



JUDICIAL COUNCIL OF CALIFORNIA

455 Golden Gate Avenue · San Francisco, California 94102-3688
www.courts.ca.gov

REPORT TO THE JUDICIAL COUNCIL

For business meeting on March 14–15, 2019

Title	Agenda Item Type
Language Access: Video Remote Interpreting (VRI) Pilot Project and Recommended Guidelines for VRI	Action Required
Rules, Forms, Standards, or Statutes Affected	Effective Date
Not applicable	March 15, 2019
Recommended by	Date of Report
Language Access Plan Implementation Task Force	January 15, 2019
Hon. Mariano-Florentino Cuéllar, Chair	Contact
Judicial Council Information Technology Advisory Committee	Douglas G. Denton, 415-865-7870
Hon. Hon. Samantha P. Jessner and	douglas.denton@jud.ca.gov
Mr. David H. Yamaski, Members and Co-Executive Sponsors, VRI Workstream	

Executive Summary

Pursuant to recommendations in the Judicial Council's *Strategic Plan for Language Access in the California Courts*, the Language Access Plan Implementation Task Force and Judicial Council staff conducted a six-month pilot project for video remote interpreting (VRI) in 2018. The pilot was evaluated by an independent, third-party evaluator, San Diego State University (SDSU) Research Foundation. The pilot was successful in demonstrating that when properly installed and utilized by trained court interpreters, judges and other court staff, VRI equipment allows meaningful participation by limited English proficient (LEP) court users and provides a solution to increase access to qualified interpreters. Among its recommendations, the task force recommends that the council approve updated Language Access Plan guidelines for VRI, which

now include guidelines for recommended minimum technology requirements, and to direct council staff to begin and implement a coordinated VRI Program for the branch in 2019.

Recommendations

The Language Access Plan Implementation Task Force and Judicial Council Information Technology Advisory Committee make the following recommendations to the Judicial Council:

1. Adopt the updated Language Access Plan guidelines for Video Remote Interpreting, which now include guidelines for recommended minimum technology requirements (see Attachment A).
2. Direct Judicial Council staff to create Leverage Purchase Agreements for courts with the two approved VRI vendors that successfully participated in the VRI Pilot Project.
3. Direct Judicial Council staff in Court Operations Services and Information Technology to begin and implement a coordinated VRI Program for the branch in 2019.
4. Direct staff to regularly report on implementation progress of the VRI Program to the council, including any need for refinement of the VRI guidelines, identification of funding needs, and/or development of new rules or forms to support appropriate use of VRI.

Relevant Previous Council Action

On January 22, 2015, the Judicial Council adopted the *Strategic Plan for Language Access in the California Courts*.¹ The Language Access Plan (LAP) provides a consistent statewide approach to ensure language access for all LEP court users in California in all 58 superior courts. The plan also proposes the thoughtful and responsible deployment of technological solutions, such as appropriate use of video remote technology and multilingual audiovisual tools, which provide language access while ensuring due process and high-quality language services.

A task force was formed by the Chief Justice in March 2015, chaired by Hon. Mariano-Florentino Cuéllar, to advise the council on implementation of the LAP's 75 recommendations. To increase LEP court user access to qualified interpreters, the LAP allows for the proper use of video remote interpreting (VRI) in the courts:

12. The use of in-person, certified and registered court interpreters is preferred for court proceedings, but courts may consider the use of remote interpreting where it is appropriate for a particular event. Remote interpreting may only be used if it will allow LEP court users to fully and meaningfully participate in the proceedings.

¹ The *Strategic Plan for Language Access in the California Courts* (LAP) is available at www.courts.ca.gov/documents/CLASP_report_060514.pdf.

Two additional LAP recommendations were specifically designed to help inform and support the successful implementation of VRI:

14. The Implementation Task Force will establish minimum technology requirements for remote interpreting which will be updated on an ongoing basis and which will include minimum requirements for both simultaneous and consecutive interpreting.

16. The Judicial Council should conduct a pilot project, in alignment with the Judicial Branch's Tactical Plan for Technology 2014–2016. This pilot should, to the extent possible, collect relevant data on: due process issues, participant satisfaction, whether remote interpreting increases the use of certified and registered interpreters as opposed to provisionally qualified interpreters, the effectiveness of a variety of available technologies (for both consecutive and simultaneous interpretation), and a cost-benefit analysis. The Judicial Council should make clear that this pilot project would not preclude or prevent any court from proceeding on its own to deploy remote interpreting, so long as it allows LEP court users to fully and meaningfully participate in the proceedings.

On June 24, 2016, the Judicial Council approved a VRI Pilot Project to evaluate potential video remote interpreting (VRI) equipment solutions and other factors which may contribute to the successful, appropriate and efficient use of VRI technology in the California courts.² The goals of the VRI Pilot Project included evaluating equipment solutions; defining statewide technical minimum standards; validating LAP VRI programmatic/usage guidelines (LAP Appendices B–D); collecting relevant data on due process issues and participant satisfaction; and establishing leveraged purchase agreements with vetted equipment vendors so courts have an efficient method to expand access using approved video remote interpreting solutions.

The Language Access Plan Implementation Task Force (LAPITF) and its subcommittee, the Technological Solutions Subcommittee (TSS), lead the VRI Pilot Project in collaboration with the Information Technology Advisory Committee (ITAC) and the Judicial Council Technology Committee (JCTC) with direct participation by three pilot courts representing small, medium, and large-sized courts (Superior Court of California, Counties of Merced, Ventura, and Sacramento).

A Request for Proposals (RFP) for the VRI Pilot Project was issued by the council on August 8, 2016.³ The high-level requirements included meeting the National Center for State Courts (NCSC) minimum technical requirements for VRI; reliability (the pilot tested whether the VRI equipment can meet a 90% pass-fail rate); and supporting different modes of interpretation by providing simultaneous and consecutive interpretation capability, as well as private sidebar (attorney-client) interpretation capability. Through the RFP process, the council received four

² The June 24, 2016 council report is available at <https://jcc.legistar.com/View.ashx?M=F&ID=4494530&GUID=0B914468-F0DD-43D9-90A6-0694510BB093>.

³ The RFP materials for the VRI Pilot are available at <http://www.courts.ca.gov/34973.htm>.

vendor responses. The RFP review team, which included court interpreters who tested the equipment, selected three vendors for the VRI Pilot. After one vendor withdrew its proposal, the council ultimately moved forward with two vendors that both use Cisco equipment: Connected Justice Consortium and Paras and Associates.

In addition to project managers at each of the three pilot courts, a VRI Workstream which reported to ITAC was also established to help guide the pilot project. Judicial officers, court interpreters, and technology experts from across the state were involved to consult on development of VRI training for all stakeholders; to review evaluation findings at the conclusion of the pilot; to develop proposed minimum VRI technical guidelines; to provide input on the LAP's VRI usage guidelines; and to recommend any new rules of court to develop, and/or make recommendations on appropriate statewide use of VRI following the pilot. The information that follows is based on the six-month VRI pilot which commenced in February 2018 and concluded in July 2018, and post-pilot review as described above by the VRI Workstream.

Analysis/Rationale

Pilot structure

Following training on the VRI equipment in January 2018 at the three pilot courts with the two vendors and all court participants (judges, courtroom staff including clerks and bailiffs, court IT staff, and court interpreters), the six-month VRI Pilot began in February 2018 in the three courts: Ventura, Merced, and Sacramento Courts. Each county designated two courthouses for the pilot (one with the Connected Justice equipment, and one with the Paras and Associates equipment). Each county also selected a building (either in the same courthouse or a different building) for the separate VRI interpreter workstation that was provided by each vendor to communicate with the vendor's equipment in the courtroom. Paras and Associates utilized the California Court Technology Center (CCTC) for its communication network, while Connected Justice utilized the pilot court's wireless network to enable communication. This enabled the council to test the two equipment vendors under different network options (see Attachment B for the basic VRI equipment setup used during the pilot).

The case types during the VRI pilot were primarily short felony and traffic arraignments, with some traffic pleas, traffic trials, and civil matters being heard (see Attachment C). Whenever possible, courts would ensure that a secondary/virtual interpreter stayed with the litigant after the court proceeding, in some instances by moving from a screen in the courtroom to another area in the court on a different screen. This enabled an interpreter to continue to assist the litigant and with facilitating LEP litigant surveys regarding the use of VRI (see below).

San Diego State University (SDSU) Research Foundation was retained to perform an independent pilot evaluation. SDSU participated in trainings at the courts regarding data collection prior to commencement of the pilot. During the pilot, the SDSU evaluation included event surveys for VRI and non-VRI events that were filled out by participating judges, courtroom staff, court IT staff, court interpreters, and LEP court users (see Attachment C). The event survey information was transmitted directly from courts to SDSU for analysis. The SDSU

researchers also conducted site visits for observation, and conducted a post-pilot online survey with pilot stakeholders (including participating judges, staff and court interpreters) that were involved in the pilot (see Attachment C).

Pilot findings

Due process refers to both substantive and procedural fairness afforded to litigants involved in a court proceeding. Concerns have been raised by opponents of VRI who contend that only in-person interpretation provides due process, and, therefore, VRI poses a threat to LEP individuals’ rights to due process. It was determined with council staff that it was beyond the scope of the SDSU evaluation to define due process or to ascertain what factors may be detrimental to a litigant’s due process protection (for example, delayed court proceedings due to rescheduling because of the unavailability of a court interpreter, or misinterpretation from the use of non-certified/non-registered or provisionally qualified interpreters). Due process concerns for LEP persons were, therefore, primarily assessed by evaluating the *communication effectiveness* of the VRI equipment, and by reviewing data collected during and after the pilot from key stakeholders (for example, from LEP court users, judges, court interpreters, and attorneys).⁴

Major pilot findings from the SDSU evaluation (see Attachment C) are summarized below:

Category	Finding
Perceived Satisfaction with and Effectiveness of VRI	Ninety-five percent (95%) of surveys completed by judicial officers indicated that judicial officers determined VRI allowed for effective communication between the LEP court user and the courtroom.
Perceived Satisfaction with and Effectiveness of VRI	Fifty-nine percent (59%) of post-pilot survey respondents (which included court interpreters) determined that VRI allowed LEP court users to meaningfully participate in court proceedings.
Perceived Satisfaction with	Event survey data from both judicial officers and interpreters indicated that 61% of the responses considered VRI “very effective”

⁴ The evaluation used only court employee interpreters who were certified or registered and assumed that all certified/registered interpreters are qualified to provide equally effective interpreting services. If we assume all certified/registered interpreters are equally qualified, the differences between the two modalities are primarily structural/technical, and the comparison of VRI and in-person interpreting modalities is essentially an assessment of whether or not the use of VRI technology for interpreting court events generates a significant difference in the effectiveness of communication during these events. Attorneys who participated in the VRI Pilot were invited to participate in the post-pilot online survey, however, none responded. Judicial Council staff and the pilot courts also determined at the end of the pilot that the VRI pilot structure prevented effective collection of data in the area of costs and scheduling. Because the pilot courts only used court employees for VRI events, the pilot was not able to provide a cost-benefit analysis on (1) costs of VRI events versus non-VRI events and (2) the number of events that were rescheduled or delayed due to the lack of availability of a registered/certified interpreter for the in-person and the VRI courtrooms.

Category	Finding
and Effectiveness of VRI	relative to the gold standard of in-person interpretation, while 34% of the response considered VRI as “somewhat effective.” In all, 95% of the responses considered VRI either “very effective” or “somewhat effective.”
Perceived Satisfaction with and Effectiveness of VRI	These responses varied significantly based on respondent group. In the post-pilot survey, more than half of the court interpreters either disagreed (44%) or strongly disagreed (14%) that VRI provided effective interpreting. However, more than half of all judicial officers, interpreter coordinators, IT staff, and other court staff either strongly agreed or agreed that VRI provided effective interpreting.
LEP Court User Satisfaction With VRI	Over three-quarters (78%) of the LEP court users who were surveyed immediately after receiving VRI were very satisfied with the interpreting they received.
LEP Court User Satisfaction With VRI	Additionally, 96% of LEP court users who were provided with VRI found the equipment easy to use.
Case Events	Post-pilot survey respondents determined that VRI was most effective for infraction and traffic cases, and for out-of-custody defendants.
Vendor Differences	Within the event survey data, there was a small but statistically significant difference ($p < .05$) in the perceived effectiveness of VRI based on vendor. Overall, events using Paras and Associates VRI technology were perceived slightly more effective than those using technology provided by Connected Justice Consortium.
Technical Aspects	The overwhelming majority (over 90%) of all event surveys indicated that participants could see and hear all other court participants clearly.
Technical Aspects	Ninety-four percent (94%) of the event surveys indicated that during VRI pilot events the audio and video feeds were synchronized. There was no significant difference found between the two vendors on this issue.
Technical Aspects	99% of event surveys completed by court staff indicated that there were no technical problems with the VRI equipment that delayed the start of the court proceeding more than 10 minutes and only 10 events (3%) where a technical problem with the equipment delayed an event more than two minutes once it was already started.

Based on review of the pilot findings and input from the pilot court project managers, Judicial Council staff determined that both vendors (Paras and Associates and Connected Justice Consortium) met the requirements of the RFP, including the 90% pass-fail rate.⁵

Recommended best practices for VRI use in courtrooms include having judicial officers introduce all court participants, reminding all participants to speak clearly, slowly, and one at a time, and obtaining LEP consent to using VRI on the record. Our completed VRI pilot reinforced many of the common themes in the SDSU study regarding VRI from other jurisdictions, namely, all involved parties (judges, attorneys, interpreters, and court staff) should receive comprehensive training in VRI procedures; printed event checklists, benchcards, or other procedural materials should be developed and consistently implemented; and interpreters assigned to VRI should be provided with sufficient training, support, advance notice, and any necessary documentation prior to an event. (See Attachment C at p. 4.)

Recommended minimum technology requirements

Judicial Council staff in Information Technology (IT) worked with the three pilot courts to review and document the equipment set up used by the two vendors during the pilot. They reviewed the pilot performance for the two vendors, as compared to the objectives of the RFP. The three pilot courts also worked with IT to develop recommended minimum technology requirements for VRI based on the pilot, and the NCSC was also retained to help review the recommended requirements (See Attachment B).

Policy implications

The LAP adopted by the council includes guidelines for VRI, including Prerequisites, Considerations, and Guidelines for Remote Interpreting in Court Proceedings (see LAP Appendix B). The LAP also includes Suggested Language for the Judicial Officer When Considering Objections Related to Remote Interpreting (see LAP Appendix C), and Visual/Auditory Issues, Confidentiality, and Modes of Interpreting When Working Remotely (see LAP Appendix D). LAP Appendix B contains suggested guidelines for remote interpreting in court proceedings based on current best practices and, as such, was subject to updating and revision by the council to accommodate advances in technology that will help ensure quality communication with LEP court users. LAP Appendix B also had a placeholder for minimum technology requirements for remote interpreting, pending the outcome of this pilot. The NCSC worked with Judicial Council staff and the VRI Workstream to review LAP Appendices B-D and updates have been made to the VRI guidelines based on the pilot findings. The revised LAP VRI guidelines, which now include guidelines for recommended minimum technology requirements, are attached hereto as Attachment A.

⁵ The VRI Pilot Project successfully tested both vendor's equipment for inter-court operability (from courthouse to courthouse within the same county) for actual case events. During demonstrations, interpreters from one pilot court were also able to successfully call into a remote courtroom in a different county. The demonstration tests for at least one vendor were successful in linking the three pilot courts together across counties.

Comments

Judges, court staff and court interpreter employees who participated in the pilot submitted several comments in both the event surveys and the post-pilot online stakeholder survey conducted by SDSU. At times interpreters experienced frustration with the pilot or the VRI equipment (the task force recognizes that the use of and mastery of new equipment required a great deal of patience from all pilot participants). Interpreters did recognize that VRI has the potential to help improve LEP court user access to interpreters in unusual languages, and is likely appropriate for short, uncomplicated case events like routine traffic matters, initial arraignments or continuances. Judges and court staff also indicated that for those languages that are limited in resources, VRI offers an affordable and more efficient delivery of service to LEP court users all across the state that avoids continuances and expensive travel costs. They indicated that VRI can expedite case resolutions, which helps the system overall and improves access to justice to all court users. Participants agreed that proper training on the VRI equipment is essential and that the VRI guidelines will need to be closely followed to ensure appropriate use of VRI.

On December 14, 2018, the VRI Workstream met via WebEx to review this draft report and recommended guidelines for VRI. No major concerns were raised regarding the drafts, but an interpreter member asked if he could share the draft report and guidelines with the California Federation of Interpreters (CFI) for additional review and comment. This request was granted, and on December 28, 2018, CFI and the Interpreters Guild of America (IGA) submitted a joint letter with comments (see Attachment D). The Co-Executive Sponsors of the VRI Workstream reviewed these comments carefully and determined that (1) they disagreed with the characterization that the VRI pilot was not successful, (2) many of the points raised in the letter were bargaining issues that were not appropriate for guidelines, and (3) other suggestions regarding VRI practices were not appropriate for guideline changes but could potentially be woven into a separate VRI best practices document that is currently under development by the NCSC as an additional resource for courts, as part of its current contract with the council.

Alternatives considered

While the use of in-person, certified and registered court interpreters is preferred for court proceedings, the LAP states that courts may consider the use of remote interpreting where it is appropriate for a particular event. The VRI pilot was successful in demonstrating that when properly installed and utilized by trained court interpreters, judges and other court staff, VRI equipment allows meaningful participation by limited English proficient (LEP) court users and provides a solution to increase access to qualified interpreters. An alternative for the branch to not go forward with video remote interpreting would be contrary to the goals of the LAP and limit LEP court user access to qualified interpreters, especially in languages of lesser diffusion.

Fiscal and Operational Impacts

The VRI Pilot was a “no-cost” pilot for the participating pilot courts, although the pilot courts including judges, court project managers, courtroom staff, court IT staff, and court employee interpreters, put in significant time and energy to make the pilot successful. The 2017 Budget also included funding for the pilot, which helped council staff to support infrastructure support

for the three pilot courts, including network needs and ancillary equipment. Long-term expansion of the VRI pilot into a VRI program will require supplemental funding for equipment, training and operational costs. Judicial Council IT staff will also need to develop a network infrastructure plan to allow communication between courts, and ideally, between the two vendors. Following this report, council staff will work to create Leverage Purchase Agreements for courts with the two approved VRI vendors that successfully participated in the VRI Pilot Project. Council staff will also need to be designated to update VRI resources, including training materials, and to regularly report on implementation progress of the VRI Program to the council, including any need for refinement of the VRI guidelines, identification of funding needs, and/or development of new rules or forms to support appropriate use of VRI.

Attachments and Links

- A. Recommended Guidelines for VRI for Spoken Language-Interpreted Events
- B. Recommended Technical Guidelines for VRI (IT Technical Report on VRI Pilot)
- C. San Diego State University (SDSU) Final Evaluation Report
- D. December 28, 2018 Comments from CFI and IGA

CALIFORNIA JUDICIAL BRANCH

Recommended Guidelines for Video Remote Interpreting (VRI) for Spoken Language-Interpreted Events

January 11, 2019 (Draft)



Table of Contents

Introduction	3
About VRI	3
About These Guidelines	5
Prerequisites, Considerations, and Guidelines for Remote Interpreting in Court Proceedings.....	6
Prerequisites	6
Considerations for determining appropriateness of VRI for court event	7
Guidelines for using VRI in a court proceeding	8
Suggested Language for the Judicial Officer When Considering Objections Related to Remote Interpreting.....	9
Visual/Auditory Issues, Confidentiality, and Modes of Interpreting When Working Remotely ..	10
Appendix A — Guidelines for Minimum Technical Requirements	12

DRAFT

Introduction

California is home to a very diverse population, with over 200 languages and dialects spoken within its borders. Approximately 7 million of its residents are limited English proficient (LEP), meaning they read, write, speak or understand English “less than very well.” Federal laws, such as Title VI of the Civil Rights Act of 1964 and Executive Order 13166, ensure that these individuals have meaningful access to any program or activity receiving federal financial assistance by prohibiting discrimination on the basis of race, color, or national origin. Accordingly, LEP individuals must be able to access the court system in a meaningful manner. In an effort to address this need, in January 2015, the Judicial Council of California adopted the [Strategic Plan for Language Access in the California Courts](#) (Language Access Plan, or LAP), which provides the foundational components for ensuring that all LEP court users in the state have equal access to justice and sets forth guidance and recommendations to help courts expand their language services at the local court level. Two main components of the LAP are to increase qualified interpreter services in any court-ordered, court-operated proceeding as well as to increase the availability of language access services to all court users. The use of technological solutions to expand such services is a component of this plan and is specifically addressed by Goal 8 of the LAP, which highlights the need to incorporate technology to provide access in courtroom proceedings, through the provision of remote interpreting and the establishment of minimum technology requirements to facilitate its use.

About VRI

In order to achieve the goal of universal provision of interpreters in judicial proceedings, the LAP notes that appropriate use of technology must be considered. From the use of various forms of remote interpreting (telephonic or video) to developing multilingual audiovisual material, technology will, by necessity, be part of any comprehensive solution to the problem of lack of language access in judicial proceedings.

The use of remote interpreters in courtroom proceedings can be particularly effective in expanding language access. To increase LEP court user access to qualified interpreters, the LAP allows for the proper use of video remote interpreting (VRI) in the courts:

12. The use of in-person, certified and registered court interpreters is preferred for court proceedings, but courts may consider the use of remote interpreting where it is appropriate for a particular event. Remote interpreting may only be used if it will allow LEP court users to fully and meaningfully participate in the proceedings.

The LAP also notes that the quality of interpretation is of paramount importance and should never be compromised. Generally, an in-person interpreter is preferred over a remote interpreter but there are situations in which remote interpreting is appropriate and can be used with greater efficiency. Remote interpreting, however, may only be used where it will allow LEP court users to fully and meaningfully participate in the proceedings.

Among the benefits of remote interpreting is the facilitation of prompt availability of language access for litigants by providing certified and registered interpreter services with less waiting time and fewer postponements; this saves both the court user's and the court's valuable time. In addition, having qualified interpreters more readily available through remote interpreting can decrease the use of less qualified interpreters, can decrease dismissals for failure to meet court deadlines, and can decrease the frequency of attorneys or parties waiving interpreter services or proceeding as if the LEP person is not present, in order to avoid delays. By decreasing interpreter travel time between venues and increasing the number of events being interpreted by individual interpreters, remote interpreting allows more LEP litigants to be served, in more areas, utilizing the same personnel and financial resources, thereby greatly expanding language access.

Remote access is not just for interpreting; it is a means to provide a whole variety of services in places far away from our courthouses. For example, where satellite courts have been closed, or where jails are far away from courthouses, remote technology has allowed courts to continue to provide a level of service to those locations. Brief proceedings, such as arraignments, can also be done remotely, saving travel time and costs. It is important that courts, and the branch as a whole, integrate language access planning with information technology planning, to accommodate and anticipate all the differing capabilities expected of remote access technology for total bandwidth, infrastructure, equipment, and training.

Any introduction of remote interpreting in the courtroom will have to include, in advance, appropriate training and education for all court personnel who will be involved in the court proceedings. Judicial officers, interpreter coordinators, and other court staff will need to be familiar with the factors that make an event appropriate for remote technologies, as well as with the technologies themselves, and with the potential drawbacks of using remote technology, so problems can be anticipated or resolved quickly, or the remote interpretation terminated. Judicial officers in particular will have to understand the remote interpretation process to ensure they are managing the courtroom and the proceedings appropriately. Suggested language for the judicial officer when considering objections related to remote interpreting is provided in these guidelines. Similarly, interpreters will have to be trained on the use of the technologies utilized by the court, as well as on the particular challenges that remote interpretation could present, such as the earlier onset of interpreter fatigue, an inability to adequately see or hear the participants, and the criticality of immediately reporting any impediment to performance or other ethical issues. Court staff must be trained and available to repair any technical problems with the equipment.

About These Guidelines

The LAP includes guidelines for VRI, including Prerequisites, Considerations, and Guidelines for Remote Interpreting in Court Proceedings (see LAP Appendix B). The LAP also includes

Suggested Language for the Judicial Officer When Considering Objections Related to Remote Interpreting (see LAP Appendix C), and Visual/Auditory Issues, Confidentiality, and Modes of Interpreting When Working Remotely (see LAP Appendix D). LAP Appendix B contains suggested guidelines for remote interpreting in court proceedings based on current best practices and, as such, was subject to updating and revision by the council to accommodate advances in technology that will help ensure quality communication with LEP court users. LAP Appendix B also had a placeholder for minimum technology requirements for remote interpreting, pending the outcome of the pilot for spoken-language interpreting conducted in 2018. The revised LAP VRI guidelines, which now include minimum technology requirements, follow.

Prerequisites, Considerations, and Guidelines for Video Remote Interpreting in Court Proceedings¹

Before a court begins using video remote interpreting (VRI) they must meet certain prerequisites that are outlined below. Additionally, prior to selecting VRI for a particular courtroom event the court must consider, at minimum, the following specific factors for determining the appropriateness of VRI. When utilizing VRI for a courtroom event the court must adhere to the guidelines below.

Prerequisites

A. Minimum Technology Requirements for Remote Interpreting:

Prior to instituting VRI in any proceeding, the court should ensure that it has the equipment and technology to provide high quality communications. (See Appendix A for Guidelines for Minimum Technical Requirements).

¹ These guidelines contain suggested guidelines based on current best practices and, as such, should be subject to updating and revision to accommodate advances in technology that will help ensure quality communication with LEP court users.

B. Training:

Prior to instituting VRI in a proceeding, the court should ensure that all persons who will be involved in the VRI event have adequate training in the use of the equipment, in interpreting protocols, and in interactions with LEP persons.

Considerations for determining appropriateness of VRI for court event

Not all courtroom proceedings are appropriate for VRI. The initial analysis for determining whether a court proceeding is appropriate for VRI will most likely be made by the interpreter coordinator who may choose to consult with the interpreter being considered for the assignment. Courtroom proceedings that are lengthy, complex, or involve more than simple evidence are not typically appropriate for VRI. Additionally, the interpreter coordinator or the judicial officer or both should consider all of the following before deciding to use VRI:

- The anticipated length and complexity of the event, including complexity of the communications involved;
- The relative convenience or inconvenience to the court user;
- Whether the matter is uncontested;
- Whether the proceeding is of an immediate nature, such as arraignments for in-custody defendants, bail reductions, and temporary restraining orders;
- Whether the LEP party is present in the courtroom;
- The number of court users planned to receive interpretation from the same interpreter during the event;
- The efficient deployment of court resources;
- Whether the LEP party requires a relay interpreter, e.g., where there is an interpreter for an indigenous language who relays the interpretation in Spanish. (The need for a relay interpreter does not preclude the use of VRI, but might necessitate the presence of at least one of the interpreters in the courtroom.)

Guidelines for using VRI in a court proceeding

1. Need to Interrupt or Clarify, and Suspend and Reschedule

When using VRI the court should consult with the interpreter to determine how best to facilitate interruptions or clarifications that may be needed. The court should suspend and reschedule a matter if, for technology or other reasons, VRI is not facilitating effective communication, or if the interpreter finds the communications to be ineffective.

2. VRI and VRI Challenges

The court shall be mindful of the particular challenges involved in remote interpreting, including increased fatigue and stress; events involving remote interpreting should have shorter sessions and more frequent breaks.

3. Participants Who Must Have Access

The remote interpreter's voice must be heard clearly throughout the courtroom, and the interpreter must be able to hear all participants.

4. Visual/Auditory Issues, Confidentiality, and Modes of Interpreting

VRI is generally preferred over other methods of remote interpreting that do not provide visual cues, such as telephonic interpreting. However, there will be situations where VRI is not possible or is not necessary. (See below for visual/auditory issues and requirements for confidentiality that must be considered and accounted for when implementing VRI.)

5. Documents and Other Information

The court shall ensure the availability of technology to communicate written information to the interpreter including a copy of exhibits being introduced, as well as information after a proceeding, such as an order, so the interpreter can provide sight translation to the LEP individual if needed.

6. Professional Standards and Ethics

The same rules for using qualified interpreters apply to assignments using VRI. It is the intent of the language access plan to expand the availability of certified and registered interpreters through the use of VRI. All interpreters performing VRI should be familiar

with, and are bound by, the same professional standards and ethics as onsite court interpreters.²

7. Data Collection

- a. Courts using VRI in the courtroom should monitor the effectiveness of their technology and equipment, and the satisfaction of participants.
- b. For purposes of supporting funding requests, courts should track the benefits and resource savings resulting from VRI on an ongoing basis (e.g., increased certified/registered interpreter availability to assist with additional events due to the use of VRI, and any cost savings).

Suggested Language for the Judicial Officer When Considering Objections Related to Remote Interpreting

We will have a court certified/registered _____ (insert language) _____

interpreter help us with these proceedings.

The interpreter is at a remote location and will appear in court via video- (or audio-) conference. Please remember to speak slowly and clearly and not speak at the same time as each other.

Do parties and counsel have any objections to the interpreter participating by remote interpreting for today's proceedings?

[Judge rules on objections, if any, or assists in resolving concerns.]

If proceeding with VRI (or audio):

² The requirements for provisionally qualifying an interpreter can be found in Government Code section 68651(c) and California Rules of Court, rule 2.893.

Parties and counsel had no objections to the use of remote interpreting, so the court will proceed with today's hearing.

[or]

Parties and counsel objected to the use of remote interpreting, but the court has overruled those objections, so the court will proceed with today's hearing.

If not proceeding with VRI (or audio):

Parties and counsel objected to the use of remote interpreting. The court will not continue with today's hearing at this time and will reset this matter for a qualified (insert language) _____ language interpreter to be available in person.

Suggested Language to Include in the Minutes:

Interpreter (name) _____ is present by video remote conferencing (or audio) and sworn to interpret (insert language) _____ language for (name) _____. (If appropriate) Sworn oath on file with the Superior Court of California, County of _____.

Visual/Auditory Issues, Confidentiality, and Modes of Interpreting When Working Remotely

1. A clear view of the LEP court user is more important than a view of every speaker; although cameras on all stakeholders may be beneficial, it may not be essential. A speakerphone is not recommended unless it accommodates the other requirements of these guidelines, including the ability to be part of a solution to allow for simultaneous interpreting when needed.
2. To ensure the opportunity for confidential attorney-client conferencing, the attorney

should have available an individual handset, headset, or in-the-ear communication device to speak with and listen to the interpreter.

3. Interpreting in the courtroom regularly involves both simultaneous and consecutive modes of interpreting. This can be achieved in a variety of ways using existing and emerging technologies. In longer matters, failure to have a technical solution that can accommodate simultaneous interpreting will result in delays of court time and may cause frustration with remote interpreting. Courts should use a technical solution that will allow for simultaneous interpreting. However, there may be proceedings (for example, very short matters) in which consecutive interpreting is adequate to ensure language access.
4. Recognizing that courts may implement very different technical solutions for VRI, it is critical that prior to the start of an interpreted event all parties, judicial officers, court staff, and officers of the court (including attorneys and interpreters) know how to allow for confidential conferencing when needed.
5. All participants, including the LEP party and the interpreters, need to check microphone and/or camera clarity before beginning interpretation.
6. Both VRI interpreters and courts should have technical support readily available.
7. Clear, concise operating instructions should be posted with the VRI equipment.

Note: There are different and other visual considerations, including visual confidentiality, if using VRI with American Sign Language (ASL). Please see www.courts.ca.gov/documents/CIP-ASL-VRI-Guidelines.pdf for a complete discussion of using VRI with ASL-interpreted events.

Appendix A — Guidelines for Minimum Technical Requirements

The following are the recommended minimum technical requirements for each of the components needed to conduct a VRI-interpreted court event. These specifications were developed based on findings from the spoken-language pilot study conducted in participating courts using equipment from the two approved pilot equipment vendors: Paras and Associates and Connected Justice. Performance cannot be guaranteed should courts choose equipment that deviates from these recommended minimum requirements. It is recommended that all technological requirements and equipment be thoroughly tested prior to any VRI event to provide high quality communication.

Component	Technical Requirements
Video Screen	A flat-panel touchscreen LCD display, with a minimum screen size of 14 inches (measured diagonally from corner to corner) for VRI providers. A 55-inch flat-screen HDTV is sufficient for medium-size courtrooms; typically installed on a media cart, alternatively on a wall-mounted arm that articulates to afford optimal viewing of courtroom audience. For a view from the bench, either another 55-inch display is oriented to the Judge’s bench, or a smaller 7- inch LCD monitor installed for the judge.
Video Camera	Video resolution of 720p/30 (1280 x 720 pixels, progressive, at 30 frames per second). This is the minimum resolution to qualify as high definition. Pan and tilt capabilities with 8x total zoom and remote control allow a court user to focus the camera view on a desired subject. Typically mounted on top of video screen.
Codec	The codec, or coder/decoder is a video endpoint device that integrates up to two HDTV displays and a video camera. Typically mounted alongside the courtroom HDTV and video camera to which they connect. Sometimes referred to as the SX20 video set-top box.

Component	Technical Requirements
Video-enabled IP phone	Minimum video resolution of 720p, 5-inch widescreen display. Must support two handsets or headsets for use when used by LEP and their counsel in client-attorney communications with the interpreter.
Document Camera or Scanner	These devices will allow the remote interpreter to provide sight interpretation of written material, e.g., recitation, if presented during the LEP's hearing.
Court Public Address (PA) system	The remote interpreter needs to be able to hear everyone in the courtroom. This can be accomplished with an audio mixer that takes as input microphones from the bench, the defendant, and the attorneys' positions, then feeding the audio into the SX20 codec.
Endpoint bandwidth	Every endpoint must support at least 768k video calling.
Quality of Service (QoS)	Quality of Service is a setting that prioritizes network traffic. It is applied on both edge routers in a WAN connection – actual settings are a function of a court's circuit bandwidth.
Class of Service (CoS)	Class of Service is a form of QoS used by AT&T in their MPLS offerings to define bandwidth allocation.

Additional technical considerations for implementation:

- Court IT personnel are highly encouraged to contact their assigned Judicial Council LAN/WAN design engineer for technical advice on telecom circuits. If court personnel are not sure who their design engineer is, they can email LANWAN@jud.ca.gov and the appropriate team member will respond.
- Have your local exchange carrier perform a pre-VRI network assessment to ensure data circuits are clean.
- Courts should perform an AV assessment to ensure VRI audio is considered.
- The California Courts Technology Center (CCTC) should consider use of product such as SolarWinds Network Performance Monitor to quickly detect, diagnose, and resolve multi-vendor network performance issues.



Recommended Technical Guidelines for Video Remote Interpreting (VRI) for the Judicial Branch of California

A TECHNICAL REPORT ON VIDEO
REMOTE INTERPRETING (VRI) PILOT

Table of Contents

VRI Technical Guidelines Contributors	1
A Technical Report on Video Remote Interpreting (VRI) Pilot.....	2
Background	2
PILOT OBJECTIVES AND FINDINGS	6
Meeting the VRI Charter Objectives	6
Overview of the Technical Objectives and Outcomes	6
VRI REQUEST FOR PROPOSAL (RFP) TECHNICAL REQUIREMENTS OVERVIEW AND RESULTS	8
Equipment Requirements.....	8
Technical Requirements.....	13
COURT, VENDOR AND JUDICIAL COUNCIL FINDINGS	18
Merced Findings.....	18
Ventura Findings	18
Sacramento Findings.....	18
CCTC Findings.....	19
Network Recommendations	19
Audio/Video Recommendations.....	19
Considerations for implementations	20
Minimum Technology Guidelines for VRI	20
Observations	21
VRI Questions – Court Responses	22
Minimum Technical Guidelines.....	22
VRI Questions – Court Responses	28
Findings Report and Recommendations.....	28
VRI Questions – Vendor Responses	33
Minimum Technical Guidelines.....	33
VRI Questions – Vendor Responses	37
Findings Report and Recommendations.....	37
Appendix A - VRI Implementations by Court	40
Appendix A1: Merced Implementation	41
Paras and Associates Solution	42
Connected Justice Solution.....	44
Appendix A2: Ventura Implementation.....	49

Paras and Associates Solution 50

Connected Justice Solution..... 61

Appendix A3: Sacramento Implementation 71

Paras and Associates Solution 72

Connected Justice Consortium Solution 79

Appendix B - Request for Proposal Technical Requirements 95

Equipment Requirements 95

Technical Requirements..... 96

Appendix C – Glossary..... 97

DRAFT

VRI Technical Guidelines Contributors

SUPERIOR COURTS

Superior Court of Ventura County

Ms. Tracy Clark, VRI Project Manager
Mr. John Wilson, Court IT Staff

Superior Court of Merced County

Ms. Amanda Toste, VRI Project Manager
Mr. Gus Solidum, Court IT Staff
Mr. Gualberto 'William' Maciel, Court IT Staff

Superior Court of Sacramento County

Ms. Ginger Durham, VRI Project Manager
Mr. Josh Restad, Court IT Staff

VENDORS

Paras and Associates

Ms. Melinda Paras

Cisco Connected Justice

Mr. Terry Burdett

JUDICIAL COUNCIL

Ms. Fati Farmanfarmaian, Information Technology
Mr. Albert Archangel, Information Technology
Ms. Kackie Cohen, Information Technology

(DRAFT)

Recommended Technical Guidelines for Video Remote Interpreting (VRI) for the Judicial Branch of California

A Technical Report on Video Remote Interpreting (VRI) Pilot

Draft Version 1.1 January 10, 2019

Background

On January 22, 2015, the Judicial Council adopted the *Strategic Plan for Language Access in the California Courts*. The Language Access Plan (LAP) provides a consistent statewide approach to ensure language access for all limited English proficient (LEP) court users in California in all 58 superior courts. The plan also proposes the thoughtful and responsible deployment of technological solutions, such as appropriate use of video remote technology and multilingual audiovisual tools, which provide language access while ensuring due process and high-quality language services.

A task force was formed to develop recommendations for achieving the goals of the strategic plan. Of the 75 recommendations produced by the Language Access Plan Implementation Task Force (LAPITF), two recommendations were specific to video remote interpreting (VRI).

Recommendation 14:

The Implementation Task Force will establish minimum technology requirements for remote interpreting which will be updated on an ongoing basis and which will include minimum requirements for both simultaneous and consecutive interpreting.

Recommendation 16:

The Judicial Council should conduct a pilot project, in alignment with the Judicial Branch's Tactical Plan for Technology 2014–2016. This pilot should, to the extent possible, collect relevant data on: due process issues, participant satisfaction, whether remote interpreting increases the use of certified and registered interpreters as opposed to provisionally qualified interpreters, the effectiveness of a variety of available technologies (for both consecutive and simultaneous interpretation), and a cost-benefit analysis. The Judicial Council should make clear that this pilot project would not preclude or prevent any court from proceeding on its own to deploy remote interpreting, so long as it allows LEP court users to fully and meaningfully participate in the proceedings.

On June 24, 2016, the Judicial Council approved a VRI Pilot Project to evaluate potential video remote interpreting (VRI) equipment solutions and other factors which may contribute to the successful, appropriate and efficient use of VRI technology in the California courts.

The goals of the VRI Pilot Project included:

- Evaluating equipment solutions,
- Defining statewide technical minimum standards,
- Validating LAP VRI programmatic/usage guidelines
- Collecting relevant data on due process issues and participant satisfaction, and
- Establishing leveraged purchase agreements with vetted equipment solution vendors so courts have an efficient method to expand access to interpreters to LEP litigants.

The Language Access Plan Implementation Task Force (LAPITF) and its subcommittee, the Technology Solutions Subcommittee (TSS), lead the VRI Pilot Project in collaboration with the Information Technology Advisory Committee (ITAC) and the Judicial Council Technology Committee (JCTC) with direct participation from three superior courts representing small, medium, and large courts, respectively: The Superior Courts of Merced, Ventura, and Sacramento.

A Request for Proposals (RFP) for the VRI Pilot Project was issued on August 8, 2016. The high-level requirements included the following:

- Meet the National Center for State Courts (NCSC) minimum technical requirements (defined in the RFP).
- Must be readily portable between courtrooms, located within the same court or different courts across jurisdictions.
- Must meet multiple acceptance criteria, including one or more of the following classifications:
 1. Equipment originally designed for video remote, simultaneous interpretation.
 2. Equipment that can be modified or paired with other equipment and work for simultaneous interpretation.
 3. High-end video conferencing equipment (e.g., Codec C60, EX60/EX90, etc.).
 4. Software end-point video conferencing (e.g., Jabber Video, Skype for Business) which can run on any computer. Simultaneous functionality is preferred.
 5. Fresno-type on premise solution. This is in cooperation with the cities of Coalinga and Mendota. Once a week, the two cities provide a large room, equipped to communicate via Remote Video to the Fresno Superior Court. City residents who would have to travel over 15 miles from their residence to the Fresno Superior Court are eligible to have their traffic case heard through the Remote Video Proceedings.
- Must meet the following technical minimum requirements:

Reliability - system must work all the time and every time (the pilot will test whether VRI equipment can meet a 90% pass-fail rate).

Quality - business-quality audio and video to ensure appropriate due process.

Interoperability - ability to switch among providers or use multiple providers easily:

- Use non-proprietary video and audio technical standards.
- Use widely available video and audio technical standards.

Modes of Interpretation:

- Provide simultaneous and consecutive interpretation capability.
- Provide private sidebar (attorney-client) interpretation capability.

The VRI team received four vendor responses. They selected three vendors for the VRI pilot and ultimately moved forward with two vendors - Connected Justice Consortium (CJ) and Paras & Associates (Paras).

The information that follows is based on the six-month VRI pilot which commenced in February 2018 and concluded in July 2018.

Implementation approach

Both Connected Justice Consortium and Paras and Associates hosted enterprise Cisco Unified Communications Manager servers in their respective data centers. Both vendors deployed Cisco IP Phone 8865 desktop phones featuring a color LCD screen and integrated video camera, SX20 collaboration endpoints with high definition pan-tilt-zoom cameras, and consumer-grade HDTV displays on media carts in the courtroom. In the remote interpreter offices Cisco IP phones, DX80 touchscreen displays with integrated webcams, external microphones and headsets, and audio mixers were commonly deployed.

The vendors' approach for connectivity differed. Paras and Associates established secure connections between their hosted servers and the California Courts Technology Center (CCTC), the Judicial Council's data center, via a site-to-site VPN tunnel on their respective edge firewalls. Connected Justice established connectivity to pilot courts over the internet, bypassing the CCTC, and utilizing a vendor-provided router and firewall on court premises.

The VRI equipment was deployed to the following court locations.

SUPERIOR COURT			
	MERCED	VENTURA	SACRAMENTO
PARAS AND ASSOCIATES			
Location	Merced Superior Court 627 W. 21st Street Merced, 95340	Ventura Superior Court 800 S. Victoria Avenue Ventura, 93009	Main Jail Courthouse 651 I Street Sacramento, 95814
CONNECTED JUSTICE CONSORTIUM			
Location	Los Banos 1159 G Street Los Banos, 93635	Juvenile Courthouse 4353 Vineyard Ave Oxnard, 93036	Carol Miller Justice Center 301 Bicentennial Circle Sacramento, 95826

Vendor-installed Equipment	Paras and Associates	Connected Justice Consortium
Courtroom		
Display	One Samsung 50" HDTV	Two Sanyo 50" HDTVs
Codec	Cisco SX20	Cisco SX20
Camera	Cisco Precision 40	Cisco Precision 40
Media Cart	TV stand, court-supplied wireless mics and chargers	1500VA uninterruptible power supply, digital audio server, second audio amplifier (for dome speaker), Cisco Catalyst 2960-C switch, HDMI combiner, three Cisco IP Phone 8861s, TV stand
PA equipment	Court-supplied PA gear	Three Shure gooseneck mics JBL 10" 1000W PA speaker on adjustable JBL tripod speaker stand with two bullet cameras
LEP Phone	Cisco IP Phone 8865	Cisco IP Phone 8865 and DX70
LEP Speaker	Court-supplied PA speakers	Ceiling-mounted speaker dome
Document viewer	none	WolfVision VZ-9plus
Interpreter's Office		
Integrated Display	Cisco DX80	14-inch Cisco DX70 or 23-inch DX80
Phone	Cisco IP Phone 8865	Cisco IP Phone 8865
Headset	Open ear headset w/ boom mic	JVC stereo headphones
Microphone	Bogen gooseneck mic	Audio-Technica mic and desk stand
Server Room		
Networking gear	none	Cisco 881 configured as a DMVPN router and DHCP server

PILOT OBJECTIVES AND FINDINGS

The following information provides an overview of the VRI pilot objectives, the requirements defined by the vendor Request for Proposal and the vendor’s performance against those objectives and requirements. Also included are findings from the pilot courts, vendors and the Judicial Council, gathered over the course of the VRI pilot and through a survey administered, at the conclusion of the pilot.

Meeting the VRI Charter Objectives

The pilot had several technical and due process objectives including:

- Evaluating equipment solutions,
- Defining statewide technical minimum standards,
- Validating LAP VRI programmatic/usage guidelines,
- Collecting relevant data on due process issues and participant satisfaction,
- Determining whether remote interpreting increases the use of certified and registered interpreters as opposed to provisionally qualified interpreters,
- Producing a cost-benefit analysis, and
- Establishing leveraged purchase agreements with vetted equipment solution vendors so courts have an efficient method to expand access to interpreters to LEP litigants.

Overview of the Technical Objectives and Outcomes

The following table focuses on the technical objectives of the pilot only.

Technical Objective	Key Requirement
The VRI pilot will evaluate equipment solutions, including the effectiveness of a variety of available technologies for both consecutive and simultaneous interpretation.	Equipment solutions from vendors that facilitate both consecutive and simultaneous interpretation/communication.
Outcome	
<p><i>The California VRI pilot allowed two separate vendors to deploy their respective hosted solutions at different sized courts, thereby meeting this objective. Both vendors installed state-of-the-art Cisco video endpoints and third-party peripherals capable of providing secure, high-definition video and clear audio to multiple parties within the same building and across the roughly 400 miles between the cities of Sacramento and Oxnard. Each vendor made the secure network connection to their hosting data centers in different ways. They leveraged existing network infrastructure and strove to accommodate the unique needs of each pilot court, its staff, and facilities.</i></p> <p><i>Technically, each solution can facilitate consecutive and simultaneous interpretation by remote interpreters. The technical writers are not able to say that most sessions were of the consecutive type, but one writer was present for a demo that featured a simultaneous VRI session using ASL for a hearing-impaired defendant.</i></p>	
Technical Objective	Key Requirement

The VRI pilot will define statewide technical standards.	Input from pilot courts and VRI Project Workstream members to develop draft technical guidelines for TSS, ITAC, JCTC, and then Judicial Council review and approval.
Outcome	
<i>The VRI pilot allowed the Judicial Council to evaluate the network configurations and peripheral equipment and determine the minimum requirements for effective interpreter sessions. Understanding that each court is different, a baseline configuration may be altered to accommodate the specific and unique needs of the court.</i>	
<i>In an age of rapid technology advances, the products evaluated today meet and often exceed the minimum technical standards/requirements spelled out in yesterday's RFP. Tomorrow's available equipment may be cheaper in price, include more features, or may have a different technology base.</i>	
Technical Objective	Key Requirement
The VRI pilot will assist in the development of VRI training materials for multiple stakeholder participants to include judicial officers, courtroom staff, court interpreters, and IT staff.	Vendors to provide training on use of equipment; Participation from pilot courts and workstream members to develop appropriate VRI-related training for all court participants.
Outcome	
<i>In support of the VRI pilot each vendor provided on-site training for court staff responsible for administering the VRI sessions and staff supporting the VRI equipment set-up. One of the important lessons learned is that good quality training of the remote interpreters and court staff is key to utilizing VRI effectively. For example, knowing how to mute/unmute microphones and turn on/off video streams goes a long way toward preserving confidential attorney-client communications. In another example, effective coordination between court staff and remote interpreter in adjusting audio levels might minimize the deleterious effect of echoes.</i>	
Technical Objective	Key Requirement
Review of software scheduling tools provided with VRI solutions to determine whether they may help courts with interpreter scheduling and/or data collection. (Vendor option: Scheduling software was defined as optional within the RFP)	Court review of software scheduling tools to help the Judicial Council determine their appropriateness for broader statewide usage.
Outcome	
<i>Both vendors support scheduling software functionality, but the functionality was not implemented/piloted/tested in the pilot.</i>	

VRI REQUEST FOR PROPOSAL (RFP) TECHNICAL REQUIREMENTS OVERVIEW AND RESULTS

Following are the technical requirements submitted with the RFP soliciting vendors for the VRI pilot. It should be noted, while the RFP specified requirements for supporting independent contractor interpreters, the pilot was limited to on-site court facilities. Both vendors responded that they were ready to demonstrate the capability to provide services for off-site interpreters. The VRI pilot team elected to limit the scope to on-site services and enable greater focus on data gathering in the court environment.

In assessing whether the requirements were met by the vendors, we draw a distinction between testing a feature from a technology perspective, demonstrating in a mock trial session, and satisfying the requirement through a live VRI-enabled court session.

I. Equipment Requirements

Requirement Number	Equipment Requirement Description	Mandatory/ Preferred/ Optional	Connected Justice Consortium	Paras and Associates
Overview				
E10.1	The vendor's VRI solution shall be no cost to the Judicial Branch.	Mandatory	Yes	Yes
E10.2	The vendor's VRI solution shall be comprised of the most effective state of the art solution with the best value that meets the requirements E20 thru E40.	Mandatory	Cisco equipment appeared to be current state of the art.	Cisco equipment appeared to be current state of the art.
Courtroom Equipment				

Requirement Number	Equipment Requirement Description	Mandatory/ Preferred/ Optional	Connected Justice Consortium	Paras and Associates
E20.1	Vendor to provide at least one set of any proposed solution meeting the acceptance criteria defined in requirements E20.2 thru E20.6, of courtroom equipment, and must be provided for the period of the assessment program, including training on use of the equipment.	Mandatory	Yes	Yes
E20.1.1	Equipment shall be installed in multiple courtrooms and be readily portable between locations. Courtrooms can either be located within the same court, or within different courts across different jurisdictions.	Mandatory	Yes	Yes
E20.2	<u>Criteria 1:</u> Equipment originally designed for video remote, simultaneous interpretation (audio remote only if video remote not available)	Preferred	Yes	Yes

Requirement Number	Equipment Requirement Description	Mandatory/ Preferred/ Optional	Connected Justice Consortium	Paras and Associates
E20.3	<u>Criteria 2:</u> Equipment which can be modified or paired with other equipment and work for simultaneous.	Preferred	Yes	Yes
E20.4	<u>Criteria 3:</u> High end video conferencing equipment (e.g., Codec C60, EX60s/EX90s etc.) Simultaneous functionality is preferred.	Preferred	Cisco SX20 replaced the Codec C60 Cisco DX70/DX80 replaced the EX60/EX90	Cisco SX20 replaced the Codec C60 Cisco DX70/DX80 replaced the EX60/EX90
E20.5	<u>Criteria 4:</u> Software endpoint video conferencing (e.g., Jabber, Skype) which can run on any computer. Simultaneous functionality is preferred.	Preferred	Software endpoints were not implemented	Software endpoints were not implemented
E20.6	<u>Criteria 5:</u> Fresno-type on premise solution as described in Attachment 11 .	Preferred	Both vendors' equipment exceeded Fresno-type solution as described in Jan 2016 minimum technical guidelines for VRI. Touchscreen Windows displays measuring 23 inches (DX80) replaced laptops and iPads.	Both vendors' equipment exceeded Fresno-type solution as described in Jan 2016 minimum technical guidelines for VRI. Touchscreen Windows displays measuring 23 inches (DX80) replaced laptops and iPads.
Interpreter Service Provider Equipment				

Requirement Number	Equipment Requirement Description	Mandatory/ Preferred/ Optional	Connected Justice Consortium	Paras and Associates
E30.1	<p>Vendor to provide at least 3 and up to 5 interpreter provider workstation solutions from any of the 5 acceptance criteria described for the courtroom equipment (see requirements E20.2 - E20.6), that will best work with multiple courtroom endpoints. May include more than one type of interpreter workstation solution for better comparative data.</p> <p>Interpreter end points can either be located within the same court, or within different courts across different jurisdictions.</p>	Mandatory	Yes	Yes
E30.1.1	Interpreter workstation solutions must be dedicated to interpreter services for the duration of vendor assessment period.	Mandatory	Yes	Yes
Additional Equipment				

Requirement Number	Equipment Requirement Description	Mandatory/ Preferred/ Optional	Connected Justice Consortium	Paras and Associates
E40.1	Vendor to provide a VRI solution (may be software based) for up to 5 independent contractor interpreters who need to provide services offsite and within 48 hours.	Mandatory	There were no offsite interpreters. The endpoints for interpreters were all in the courts - for both vendors.	There were no offsite interpreters. The endpoints for interpreters were all in the courts - for both vendors.

DRAFT

II. Technical Requirements

Requirement Number	Non-Functional Requirement Description	Mandatory/ Preferred/ Optional	Connected Justice Consortium	Paras and Associates
Equipment				
T10.1	The vendor's VRI solutions shall build on existing infrastructure (<i>RFP Attachment 12</i>).	Mandatory	Connected Justice solution built upon existing infrastructure.	Paras and Associates solution built upon existing infrastructure.
T10.2	The vendor's VRI solutions shall allow for point to point intra-court, inter-court, and court to independent contractor video remote interpreting.	Mandatory	Vendor conducted live point-to-point intra-court VRI sessions and IT court personnel successfully tested CJ's ability to establish inter-court connections involving Ventura court. Live VRI intercourt sessions were established between Merced and Sacramento courts only. The independent contractor video remote interpreting was not tested.	Vendor conducted live point-to-point intra-court VRI sessions and successfully demonstrated inter-court VRI sessions. No live VRI intercourt sessions were established due to procedural/administrative restrictions involving Ventura court. The independent contractor video remote interpreting was not demonstrated.

Requirement Number	Non-Functional Requirement Description	Mandatory/ Preferred/ Optional	Connected Justice Consortium	Paras and Associates
T10.3	Equipment must be portable/mobile and may be moved to different courtrooms for the duration of the assessment.	Mandatory	With the exception of overhead-mounted sound domes, the VRI equipment was mobile enough to theoretically move between courtrooms. Identifying and configuring switchports is a necessary network administration task.	The VRI equipment was mobile enough to theoretically move between courtrooms. Identifying and configuring switchports is a necessary network administration task.
T10.4	Equipment must have the ability to provide a separate and secure audio/video channel for confidential attorney-client communications.	Mandatory	Vendor tested the ability to conduct private attorney-client communications.	Vendor demonstrated the ability to conduct private attorney-client communications.
T10.5	Equipment must meet the following technical minimum requirements: Reliability - system to work all of the time and every time Quality - business-quality audio and video to ensure appropriate due process	Mandatory	Reliability - Systems were tested each time before court proceedings began. Quality - Merced reported persistent audio and video issues with inter-court sessions.	Reliability - Systems were tested each time before court proceedings began. Quality - Merced experienced audio and video issues with inter-court sessions until their WAN circuit was upgraded. Ventura experienced ongoing audio/echo issues due to the courtroom's AV system, and not necessarily due to the vendor's solution.

Requirement Number	Non-Functional Requirement Description	Mandatory/ Preferred/ Optional	Connected Justice Consortium	Paras and Associates
T10.6	Equipment should meet the following technical minimum requirements: Interoperability - ability to switch among providers or use multiple providers easily: - Use non-proprietary video and audio technical standards - Use widely available video and audio technical standards	Preferred	Interoperability - Vendor used industry-accepted video and audio technical standards and employed hosted communications provider. However, they did not provide the ability to switch court-installed equipment among multiple providers.	Interoperability - Vendor used industry-accepted video and audio technical standards and employed hosted communications provider. However, they did not provide the ability to switch court-installed equipment among multiple providers.
T10.6.1	Equipment should meet the following technical minimum requirements: Modes of Interpretation: - Provide simultaneous interpretation capability - Provide private sidebar interpretation capability	Preferred	Both modes of interpretation were tested.	Both modes of interpretation were demonstrated Ventura conducted both simultaneous and private sidebar live interpretation sessions.
T10.7	Product offering must provide at least 720p-30FPS grade video, with multi-channel audio.	Mandatory	Installed equipment met the requirements for standard high-definition video and multi-channel audio.	Installed equipment met the requirements for standard high-definition video and multi-channel audio.
T10.8	Audio signals in the 8 to 20khz range shall be reliably reproduced.	Preferred	Audio signals in the normal human voice range were reproduced.	Audio signals in the normal human voice range were reproduced.

Requirement Number	Non-Functional Requirement Description	Mandatory/ Preferred/ Optional	Connected Justice Consortium	Paras and Associates
Network Infrastructure				
T20.1	The vendor shall build its VRI solution network infrastructure using the existing LAN/WAN infrastructure (<i>RFP Attachment 13 and Attachment 14</i>).	Mandatory	Vendor built their solution to fit into existing local court LAN infrastructure. Design included a CJ-supplied firewall running in parallel to the court's internet-facing firewall.	Vendor built their solution to fit into existing CCTC LAN/WAN infrastructure.
T20.2	The vendor to provide network design specifications for its VRI product offering that does not alter the security posture of the court's network.	Mandatory	Vendor provided network design specs and ensured they did not alter the security posture of the courts.	Vendor provided network design specs and ensured they did not alter the security posture of the courts.
T20.2.1	Design specification shall include network security specifications.	Mandatory	Yes	Yes
T20.2.2	Design specifications shall include bandwidth specifications that scale for users and include options for different codecs to reduce network impact.	Mandatory	Yes	Paras and Associates solution included bandwidth specifications.
T20.2.3	Vendor to provide sample QoS settings for optimum video and voice quality.	Mandatory	Yes	Paras and Associates provided sample QoS settings.
Scalability				

Requirement Number	Non-Functional Requirement Description	Mandatory/ Preferred/ Optional	Connected Justice Consortium	Paras and Associates
T30.1	System shall provide options to scale vertically or horizontally to allow for increased adoption.	Mandatory	Yes	Yes
T30.2	VRI solution shall be scalable to accommodate court size, court users, data volume, and internet users.	Mandatory	Yes	Yes
Security				
T40.1	VRI solution shall be secure and meet the guidelines set forth in (RFP Attachment 15) and the NIST SP 800-53 standards for the back end (RFP Attachment 16).	Mandatory	The Connected Justice VRI solution undergoes annual auditing for PCI, HIPAA and SOC II TYPE II accreditations. All three accreditations overlap the NIST SP 800-53 requirements.	Yes
T40.1.1	The system must support a secure communication channel to protect communications and document transfers.	Optional	Yes	Yes
Monitoring				
T50.1	System shall provide diagnostic and monitoring functionality.	Mandatory	Hosted communications provider can provide diagnostic and monitoring functionality. However, no live VRI sessions were conducted for which to monitor.	Hosted communications provider provided diagnostic and monitoring functionality.

COURT, VENDOR AND JUDICIAL COUNCIL FINDINGS

Following is a summary of findings based on feedback and observations over the course of the pilot project. The findings at each court location, as well as the California Courts Technology Center (CCTC) served to inform the technical recommendations for future VRI implementations.

Merced Findings

- Merced started the pilot with a T1 1.5 Mbps connection to CCTC's AT&T MPLS network, thinking the bandwidth was sufficient to support one video call. This and other Merced findings led to the recommendation to perform pre-VRI network and A/V assessments.
- Wiring from the local central office to Merced pilot courthouse building turned out to have line issues, thereby masking initial configuration and troubleshooting attempts to improve call quality.
- Both Connected Justice and Paras and Associates's two separate audio path solution, at times, resulted in echo and delay to which remote interpreters reported difficulty understanding the speaker and audio feedback. Configuration tweaks and equipment swap-outs helped minimize these effects.
- The A/V systems in Courtroom 9, Merced were upgraded to connect to Paras's Cisco SX20.
- Paras's equipment randomly disconnected or unregistered from CallManager. This issue was ultimately solved by making an update to the CallManager config file. Court IT personnel had to restart the courtroom and interpreter's VRI equipment every morning due to the courtroom clerk being instructed to turn off the power strip to the VRI media cart.
- Network drops and electrical outlets were added to accommodate the connection of the Connected Justice DX70 in the vestibule, attorneys and inmate interview room, and inside Courtroom 12, Los Banos.
- A small monitor dedicated to VRI was added to the judge's bench also in Courtroom 12, Los Banos, for Connected Justice solution.

Ventura Findings

- Ventura remote interpreters reported varying degrees of echo from the Paras and Associates solution. Audio settings were adjusted, and microphones were replaced to reduce the effect and echo was reduced to a manageable level. The echo issues were determined to come from the court's AV system and not necessarily from the vendor's implementation.
- Training and experience on the part of the interpreters played a big part in reducing the effects of echo, regardless of the vendor solution.
- IT personnel used the free WinMTR network diagnostic tool to troubleshoot connectivity between the pilot courts.

Sacramento Findings

- Although the core videoconferencing equipment provided by both vendors was sufficient, both also had shortcomings. Paras did not have a solution for sound amplification or microphones in the courtroom; they relied on our facilities team to provide a solution for them. Connected Justice had sound issues throughout the pilot, mostly reported as echoes.

- Connected Justice provided small cameras positioned around the courtroom to assist the interpreter in viewing the courtroom. Interpreters almost unanimously reported that these smaller cameras were not helpful and that they preferred a single high-res wide-angle camera.
- The biggest hurdle with Paras solution was the integration with existing PA systems.

CCTC Findings

- CCTC's CA-IM network monitoring software produced weekly bandwidth utilization and protocol percentage graph reports, but they were hard to interpret and explain.
- When troubleshooting issues, it is important for all parties involved in the "pathway" to coordinate their activities, ideally in a conference call or WebEx.

The following network and audio/video recommendations are based on the findings of the VRI pilot.

Network Recommendations

Voice and video are sent over existing data networks, and during VRI sessions they compete with other traffic such as email, file transfers, web browsing, etc. Audio delay, echo or distortion results from packet loss, jitter, and latency; video pixilation likewise affects picture quality. Fortunately, the network devices can be configured for traffic shaping, low packet loss, and prioritized delivery to address these quality issues. Of note, a T1 1.54 Mbps circuit was deemed insufficient for more than one video call.

This recommendation applies to vendors providing hosted videoconferencing services:

- Reserve network bandwidth of 512 Kbps per call in Cisco Unified Communications Manager bandwidth region settings

These recommendations apply to WAN courts connecting to Paras-style VRI vendor.

- Implement QoS markings EF DSCP 46 (voice) and AF41 DSCP 34 (video) on court edge routers
- Implement CoS profile with 20% Real Time voice on court edge routers, to achieve 2Mbps reserved bandwidth for real-time traffic for up to four concurrent video calls. *(Note that a VRI session will likely consume two simultaneous calls for short periods of time.)*

Audio/Video Recommendations

- Secure audiovisual pathways should be used to ensure private attorney-client communications between the Remote Interpreter, Limited English Proficiency client (LEP), and counsel. In Paras and Associates's pilot implementation, the Remote Interpreter placed a private video call to the LEP court user's IP phone, and counsel listened on a second handset or headset. Connected Justice implemented an overhead speaker dome under which the LEP stood.
- The Remote Interpreter must have a mechanism and process to mute the microphone and block the camera feed to the courtroom while providing confidential interpretation services. The Cisco IP Phone 8865s allows for muting the microphone, and its integrated camera allows users to turn the lens clockwise/counterclockwise to open/close it.
- Flat screen displays should be sized appropriately for judge, LEP, attorneys, courtroom staff, and layout of the courtroom. Consumer-grade wide-screen HDTVs capable of displaying at standard HD 720p are sufficient for presenting the Remote Interpreter's video feed to courtroom audience.

- A document viewer will allow the Remote Interpreter to provide sight translation of written material if presented during the LEP's hearing. Other forms of transmission may also allow sight translations, such as shared access to the Case Management System, scanned/emailed documents, and faxed documents
- Audio systems should be robust enough (or have ability to be modified) to clearly broadcast the Remote Interpreter's voice to the courtroom when needed.

Considerations for implementations

- Court IT personnel are highly encouraged to contact their assigned JCC LAN/WAN design engineer for technical advice on telecom circuits, whether procured through the CALNET contract or not. If court personnel are not sure who their design engineer is, they can email LANWAN@jud.ca.gov and the appropriate team member will respond.
- Have your local exchange carrier perform a pre-VRI network assessment to ensure data circuits are clean.
- Court should perform an AV assessment to ensure VRI audio is considered.
- The CCTC should consider use of product such as SolarWinds Network Performance Monitor to quickly detect, diagnose, and resolve multi-vendor network performance issues.

Minimum Technology Guidelines for VRI

The following guidelines were developed based on the technical guidelines from the American Sign Language Pilot, technical guidelines from the National Center for State Courts, along with data, information and lessons learned from the VRI Pilot Project.

1. Video screen: A flat-panel touchscreen LCD display, with a minimum screen size of 14 inches (measured diagonally from corner to corner) for VRI providers. A 55-inch flat-screen HDTV is sufficient for medium-size courtrooms; typically installed on a media cart, alternatively on a wall-mounted arm that articulates to afford optimal viewing of courtroom audience. For a view from the bench, either another 55-inch display is oriented to the Judge's bench, or a smaller 7-inch LCD monitor installed for the judge.
2. Video camera: Video resolution of 720p30 (1280 x 720 pixels, progressive, at 30 frames per second). This is the minimum resolution to qualify as high definition. Pan and tilt capabilities with 8x total zoom and remote control allow a court user to focus the camera view on a desired subject. Typically mounted on top of video screen.
3. Codec: The codec, or coder/decoder is a video endpoint device that integrates up to two HDTV displays and a video camera. Typically mounted alongside the courtroom HDTV and video camera to which they connect. Sometimes referred to as the SX20 video set-top box.
4. Video-enabled IP phone: Minimum video resolution of 720p, 5-inch widescreen display. Must support two handsets or headsets for use when used by LEP and their counsel in client-attorney communications with the interpreter.
5. Document camera. This device will allow the remote interpreter to provide sight interpretation of written material, e.g., citation, if presented during the LEP's hearing.
6. Court PA system: The remote interpreter needs to be able to hear everyone in the courtroom. This can be accomplished with an audio mixer that takes as input microphones from the bench, the defendant, and the attorneys' positions, then feeding the audio into the SX20 codec.
7. Endpoint bandwidth: Every endpoint must support at least 768k video calling.

8. QoS: Quality of Service is a setting that prioritizes network traffic. It is applied on both edge routers in a WAN connection – actual settings are a function of a court’s circuit bandwidth.
9. CoS: In this pilot Class of Service is a form of QoS used by AT&T in their MPLS offerings to define bandwidth allocation.

Observations

- The technology allowed interpreters to work from within the same county superior court as well as facilitate the employment of interpreters from a similarly-equipped site outside the county.
- Third-party service providers could install, configure, and integrate enterprise- and commercial-grade videoconferencing equipment with consumer-grade peripherals to securely deliver voice and video communications over a court’s WAN circuit or internet connection to a hosting data center.

Every state trial court will have a unique network design based on its physical location, telecom service availability to that location, number of users and types of network traffic used, and not least of all its operating budget.

DRAFT

VRI Questions – Court Responses

Minimum Technical Guidelines

Following are actual responses from the courts to questions about the equipment installation and implementation of services for the VRI pilot.

Question 1: Were vendor-installed HD TV displays, phones, cameras and audio equipment sufficient to satisfy needs of LEP court user, interpreter, attorneys, court staff, and presiding judge for VRI sessions? <i>Intent: To ascertain whether the vendors' deployed solution met their users' functional and technical requirements for remote interpreting services.</i>	
MERCED SUPERIOR COURT Connected Justice (Los Banos)	Yes. While Connected Justice was sufficient when the equipment was functional, there were several instances where the audio quality was subpar.
MERCED SUPERIOR COURT Paras	Yes.
SACRAMENTO SUPERIOR COURT Connected Justice	Speaker system installed in courtroom never worked as expected and was inadequate for the purpose, specifically the directional speaker for LEP court user. Smaller cameras installed in the courtroom gave too small of a picture for use of the interpreters, using a single high resolution wide angle camera proved to be more convenient.
SACRAMENTO SUPERIOR COURT Paras	Vendor installed equipment was sufficient for all users. Vendor did not provide a solution for sound amplification or microphones and relied on our facilities team to come up with a solution.
VENTURA SUPERIOR COURT Connected Justice (Oxnard)	Yes – 8 on a scale of 10.
VENTURA SUPERIOR COURT Paras (Hall of Justice)	Yes – 7 on a scale of 10.
Question 2: Please comment on whether the equipment supported remote interpreter services for attorney-client privileged communications. <i>Intent: To determine whether the VRI equipment adequately enabled three-way conversations between the Limited English Proficient (LEP) court user, his/her attorney, and the remote interpreter while in the middle of the LEP's court hearing.</i>	
MERCED SUPERIOR COURT Connected Justice (Los Banos)	Vendor used Digi-Wave headsets/radio for this purpose. However, no attorney-client privileged communications were used in live VRI sessions because they were not needed for traffic hearings.
MERCED SUPERIOR COURT Paras	No, the traffic court did not involve attorneys.

SACRAMENTO SUPERIOR COURT Connected Justice	No attorney-client privileged communication was used in production. They had a solution that was installed and tested and appeared feasible, but we were never able to gather real use data.
SACRAMENTO SUPERIOR COURT Paras	The equipment supported attorney-client privileged communications.
VENTURA SUPERIOR COURT Connected Justice (Oxnard)	Yes, the equipment supported this. However, Ventura did not use this feature.in Oxnard.
VENTURA SUPERIOR COURT Paras (Hall of Justice)	Yes. This feature was used every day of the pilot.

Question 3: How were problem reports of video pixilation and/or audio jitter fixed from technical side, e.g., was bandwidth increased, traffic shaped, QoS and/or CoS tweaked, resolution adjusted downward/upward, et cetera? <i>Intent: To determine how issues such as bad video or garbled speech encountered during the pilot were managed and the types of solutions employed such as circuit upgrades or class of service settings.</i>	
MERCED SUPERIOR COURT Connected Justice (Los Banos)	Vendor did not tell how this was configured and fixed. Court only provided internet access.
MERCED SUPERIOR COURT Paras	QoS was implemented, a circuit at Merced was upgraded, bandwidth was increased; there was heavy involvement with AT&T.
SACRAMENTO SUPERIOR COURT Connected Justice	We did not have any reports of these issues during production use of the equipment.
SACRAMENTO SUPERIOR COURT Paras	We never had these issues during production use. The only time we had any of these issues was when testing between sites and those issues were corrected on the other end.
VENTURA SUPERIOR COURT Connected Justice (Oxnard)	None of these issues were experienced with the CJ system.
VENTURA SUPERIOR COURT Paras (Hall of Justice)	The only issue experienced was with connection to the Merced Court. All methods listed above were used to resolve the problem.

Question 4: What were your qualitative/quantitative measures of a successful VRI session? <i>Intent: To obtain input on quality issues such as the video freezing or hearing an echo during the sessions. The quantitative factor would highlight the frequency of the issue.</i>	
MERCED SUPERIOR COURT Connected Justice (Los Banos)	A VRI session was deemed successful if the judicial officer, LEP and interpreter reported satisfactory audio and video feeds.
MERCED SUPERIOR COURT Paras	Quantitative: call established, working audio/video, acceptable call stats (low packet lows, high FPS, stable video bitrate). Qualitative: Interpreter/Judge initiated call and operated equipment with no issue/assistance.

SACRAMENTO SUPERIOR COURT Connected Justice	All VRI sessions were deemed a success based on the experience of the Interpreter. As long as the interpreter reported a good experience then it was reported successful. We did not take quantitative measures during the production VRI sessions (unless you are referring to surveys).
SACRAMENTO SUPERIOR COURT Paras	All VRI sessions were deemed a success based on the experience of the Interpreter. As long as the interpreter reported a good experience then it was reported successful. We did not take quantitative measures during the production VRI sessions (unless you are referring to surveys).
VENTURA SUPERIOR COURT Connected Justice (Oxnard)	Successful connection, clear video and audio, ease of use.
VENTURA SUPERIOR COURT Paras (Hall of Justice)	Successful connection, clear video and audio, ease of use.

Question 5: How was the performance of your solution for intra-court VRI sessions? For inter-court sessions? <i>Intent: To obtain feedback on intra-court sessions where the remote interpreter is in the same building as the court room or in a nearby court facility, where the network connection is usually stable. Inter-court sessions refer to sessions between different courts, for example the Merced court using interpreter services at the Sacramento court.</i>	
MERCED SUPERIOR COURT Connected Justice (Los Banos)	The equipment presented technology challenges with connectivity during intra-court sessions, which led to inconsistent results. The solution had significant challenges and was not deemed reliable enough during the time constraints; it was not tested for inter-court sessions.
MERCED SUPERIOR COURT Paras	Performance for intra-court sessions was excellent; call quality, sound, and equipment performed without technical issues. Inter-court sessions suffered from poor call quality that was resolved after extensive troubleshooting with the vendor/ISP.
SACRAMENTO SUPERIOR COURT Connected Justice	Performance of both intra-court and inter-court was acceptable. We tested both voice interpreting and ASL interpreting, and both were deemed acceptable.
SACRAMENTO SUPERIOR COURT Paras	Performance of both intra-court and inter-court was acceptable. We tested both voice interpreting and ASL interpreting, and both were deemed acceptable.
VENTURA SUPERIOR COURT Connected Justice (Oxnard)	Performance was very good overall.
VENTURA SUPERIOR COURT Paras (Hall of Justice)	Performance was very good inter-court. Intra-court had issues that were resolved (see #3 above), then performance was very good.

<p>Question 6: Did court interpreters provide constructive feedback on vendor-installed equipment? Please describe any changes made based on this feedback, e.g., using different webcams, higher/lower resolution, touchscreen displays, headphones, microphones, courtroom PA systems, laptops, etc.</p> <p><i>Intent: To determine whether primary users of deployed solution provided the vendors with initial and ongoing feedback to make the elements work better together.</i></p>	
<p>MERCED SUPERIOR COURT Connected Justice (Los Banos)</p>	<p>Yes; using a switch to mute and unmute the mic and dialing what phone location to dial. Interpreters provided quite a bit of feedback on the Connected Justice equipment. The numerous steps required to switch between endpoints and to adjust the volume were distracting for the interpreter.</p>
<p>MERCED SUPERIOR COURT Paras</p>	<p>One interpreter requested over-the-ear headphones for increased quality of hearing, a push-to-talk mic was also installed partway into the project to help the interpreter manage the session between the defendant and the courtroom.</p>
<p>SACRAMENTO SUPERIOR COURT Connected Justice</p>	<p>Many changes were made throughout testing of the equipment. Initially the interpreters were instructed to use a laptop as well as the DX80, with the laptop sitting next to the DX80, but after use it was determined that this was more distracting than useful. We closed the laptop and used the DX80 as a “secondary screen” so that it could be used to interact with the laptop as well as make calls. This was reported as a better solution.</p> <p>We tested a station with only a laptop with a webcam, no DX80. After some use the interpreters requested a DX80 be installed. The laptop as a telepresence solution was not well received.</p> <p>Initially there was a “dual” headset used as microphones for both the DX80 and the cisco phone, but these were not liked. A table mic that was connected to both devices with a splitter was later installed. Eventually the table mic was replaced by a “push to talk” model.</p>
<p>SACRAMENTO SUPERIOR COURT Paras</p>	<p>The interpreters did not like the initial headsets that were provided, they were replaced with a less conspicuous model. Microphone types were switched a few times until a “push to talk” model was decided on.</p>
<p>VENTURA SUPERIOR COURT Connected Justice (Oxnard)</p>	<p>Interpreters experienced varying degrees of “echo” when using the system. They provided feedback to Connected Justice and they provided an updated “talkback” mic for the interpreters to use. Issue was resolved.</p>
<p>VENTURA SUPERIOR COURT Paras (Hall of Justice)</p>	<p>Interpreters experienced varying degrees of “echo” when using the system. They provided feedback to Court ITU and vendors who worked to minimize the effect. Audio settings were adjusted and new microphones were tested in the process. It was determined this was an issue with the court’s AV system, and not necessarily with the vendor’s solution.</p>

Question 7: Was network bandwidth sufficient for each VRI-equipped court location? If not, were there circuit upgrades made for the purposes of VRI pilot? <i>Intent: To ascertain whether existing WAN and internet circuits in each pilot court had sufficient bandwidth to permit two simultaneous VRI calls with no degradation in video or audio.</i>	
MERCED SUPERIOR COURT Connected Justice (Los Banos)	Yes.
MERCED SUPERIOR COURT Paras	A circuit upgrade [to 10 MBps] was conducted at Merced.
SACRAMENTO SUPERIOR COURT Connected Justice	Network bandwidth was sufficient.
SACRAMENTO SUPERIOR COURT Paras	Network bandwidth was sufficient.
VENTURA SUPERIOR COURT Connected Justice (Oxnard)	Yes, bandwidth was sufficient.
VENTURA SUPERIOR COURT Paras (Hall of Justice)	Yes, with exception of Merced (see #3 above).

Question 8: Given your state government network, was it difficult to install vendor-supplied firewall and DMVPN gateway equipment? <i>Intent: To determine if court IT personnel and vendors worked together to install, configure, test, and troubleshoot third-party network gear in pilot court locations, while maintaining the same level of network security.</i>	
MERCED SUPERIOR COURT Connected Justice (Los Banos)	Easy. Court only provided Internet access and the vendor configured the rest.
MERCED SUPERIOR COURT Paras	No, Court IT had access to equipment areas and coordinated without issue with JCC network and vendor the vendor/third-parties.
SACRAMENTO SUPERIOR COURT Connected Justice	Installation of vendor supplied equipment was done by Joe and he had it up and running in an afternoon.
SACRAMENTO SUPERIOR COURT Paras	Installation of vendor supplied equipment was done by Joe and he had it up and running in an afternoon.
VENTURA SUPERIOR COURT Connected Justice (Oxnard)	There was some installation and configuration of devices in our server room, but the process was completed in less than a day.
VENTURA SUPERIOR COURT Paras (Hall of Justice)	Yes; connectivity to the CCTC took a lot of time both locally and in Sac. Once the connections were established, the routing and connections were very reliable.

Question 9: What, if any, court internet router and firewall configurations were made to support VRI Pilot? Please break out by vendor and location. <i>Intent: To ascertain whether the vendor solutions were standards-based, enterprise-ready, low-touch implementations.</i>	
MERCED SUPERIOR COURT Connected Justice (Los Banos)	JCC network engineering assisted vendor in identifying a VLAN number for segregating and routing VRI traffic through the court network.
MERCED SUPERIOR COURT Paras	JCC network engineering assisted the Court IT staff in identifying a VLAN number for segregating and routing VRI traffic through the court network.
SACRAMENTO SUPERIOR COURT Connected Justice	Both vendors were given their own VLAN that was separate from the rest of our equipment. We had to ensure that any port that vendors used were on the correct VLAN.
SACRAMENTO SUPERIOR COURT Paras	Both vendors were given their own VLAN that was separate from the rest of our equipment. We had to ensure that any port that vendors used were on the correct VLAN.
VENTURA SUPERIOR COURT Connected Justice (Oxnard)	Ventura created a layer 3 VLAN at the Juvenile Justice Complex (JJC) to attach all CJ equipment. Vendor provided a DMVPN gateway and ASA firewall that was integrated into existing court infrastructure. Specific IP addresses were provided by vendor so ACL changes could be made to the Cisco ASA for increased security.
VENTURA SUPERIOR COURT Paras (Hall of Justice)	Ventura created a layer 3 VLAN at the Hall of Justice (HOJ) to attach all Paras equipment. Vendor built their solution to fit into existing CCTC LAN/WAN infrastructure.

VRI Questions – Court Responses

Findings Report and Recommendations

Following are actual responses from the courts to questions about their experiences and observations over the course of the VRI pilot.

Question 1: What were the actual go-live dates for each VRI-equipped pilot courtroom? <i>Intent: To determine how easy/difficult it was for the vendors to install their equipment, train the users, make tweaks to ensure a quality VRI experience for all involved.</i>	
MERCED SUPERIOR COURT Connected Justice (Los Banos)	Los Banos - 3/20/18
MERCED SUPERIOR COURT Paras	1/23/18
SACRAMENTO SUPERIOR COURT Connected Justice	4/10/2018
SACRAMENTO SUPERIOR COURT Paras	2/21/2018
VENTURA SUPERIOR COURT Connected Justice (Oxnard)	6/1/2018
VENTURA SUPERIOR COURT Paras (Hall of Justice)	1/22/2018
Question 2: Training on vendor equipment – was it effective, did it take repeated training sessions to use the equipment correctly? <i>Intent: To determine whether the implemented solution was simple or complex for the primary users to operate it effectively.</i>	
MERCED SUPERIOR COURT Connected Justice (Los Banos)	Connected Justice provided training; however, the repeated changes to equipment and A/V connection issues presented challenges with consistent training for staff. In addition, the vendor didn't have local support that led to challenges for support.
MERCED SUPERIOR COURT Paras	Vendor provided basic call instructions which was sufficient to train our users.
SACRAMENTO SUPERIOR COURT Connected Justice	A training was conducted, but then equipment changed repeatedly. By the end I was not all the way clear on how to troubleshoot. Some issues that occurred had to be called into Connected Justice for support.

SACRAMENTO SUPERIOR COURT Paras	Paras gave a brief training for IT and power users that was effective.
VENTURA SUPERIOR COURT Connected Justice (Oxnard)	Vendor training was adequate for staff purposes.
VENTURA SUPERIOR COURT Paras (Hall of Justice)	Vendor training was adequate for staff purposes.

<p>Question 3: Integration with existing court Public Announcement (PA) system – how easy or difficult? Please provide answer for each Superior Court location.</p> <p>Did it involve installing new equipment such as wireless mics, audio mixers, and so on?</p> <p><i>Intent: To determine whether the vendor's implemented solution worked with existing courtroom systems.</i></p>	
MERCED SUPERIOR COURT Connected Justice (Los Banos)	Los Banos site –Vendor did themselves and integrated it with the AV system.
MERCED SUPERIOR COURT Paras	JCC upgraded the AV systems to integrate VRI equipment.
SACRAMENTO SUPERIOR COURT Connected Justice	They provided their own solution for the PA system and did not use any of our existing equipment. This was beneficial to us since they provided more advanced equipment than we would have used, but it also was the root of multiple issues that delayed go live. The team they sent did not provision adequate time to setup the sound system and so they had to make a second and third trip to get it working correctly. In addition, the devices installed never worked exactly as expected; for example, the directional speaker was never able to be “tuned” optimally for the courtroom, it was either too quiet to hear well or too loud and caused feedback or echo. Their sound system relied on DSP that are difficult to program and tune correctly. These systems are beyond our ability to troubleshoot, except for the most basic issues. They were not very robust and something as simple as someone changing a volume knob would cause issues with the system.
SACRAMENTO SUPERIOR COURT Paras	Paras gave very little effort to integrate with our PA system. When we did have issues, they made it very clear that the issues were on our side and gave very little assistance. We had to work with our Facilities department to make upgrades to our sound system in the courtroom. We had to purchase wireless mics and mixers. Paras did assist in hooking the PA to their system, but this took multiple trips from them before it was working correctly.
VENTURA SUPERIOR COURT Connected Justice (Oxnard)	Integration to the Court PA system was relatively simple and easy to accomplish.

VENTURA SUPERIOR COURT Paras (Hall of Justice)	This proved to be the biggest hurdle to the pilot. It took quite a bit of work on the part of ITU staff to integrate the systems, and the configuration was later scrapped for a simpler solution that yielded the same or better audio results.
---	--

Question 4: How many consecutive interpretations were performed? How many were simultaneous? Were there technical issues that discouraged either type of interpretation? <i>Intent: To determine whether the remote interpreters were able to perform both types of interpretations using the implemented solutions.</i>	
MERCED SUPERIOR COURT Connected Justice (Los Banos)	Only the consecutive interpretation type of VRI sessions were conducted with the Connected Justice solution.
MERCED SUPERIOR COURT Paras	Both consecutive and simultaneous interpretations were conducted in live intra- and inter-court VRI sessions with Paras equipment. Inter-court sessions were conducted between Merced and Sacramento only, as Ventura had a procedural/administrative limitation, not a technical limitation.
SACRAMENTO SUPERIOR COURT Connected Justice	Event surveys completed by interpreters during the pilot indicated that across all three courts, consecutive interpreting was provided in 89% of VRI events, simultaneous interpreting was provided in 53% of VRI events, sight translation was provided in no VRI events, and interpreting for confidential conferencing between the LEP court user and his or her attorney was provided in 5% of VRI events
SACRAMENTO SUPERIOR COURT Paras	Event surveys completed by interpreters during the pilot indicated that across all three courts, consecutive interpreting was provided in 89% of VRI events, simultaneous interpreting was provided in 53% of VRI events, sight translation was provided in no VRI events, and interpreting for confidential conferencing between the LEP court user and his or her attorney was provided in 5% of VRI events
VENTURA SUPERIOR COURT Connected Justice (Oxnard)	In general, interpretations TO the LEP consumer were done simultaneously, while responses FROM the LEP consumer were done consecutively. Interpreters reported that the English from judicial officers and attorneys was more easily heard and more predictable from experience as an on-site interpreter in that courtroom, making simultaneous possible. They also stressed that the additional factors involved in working remotely made even the simultaneous interpretation slower than if they were on-site. Also, interpreting into an unknown courtroom which an interpreter is less familiar with (as will be the case with inter-court VRI) would also slow the process. LEP individuals generally speak less clearly and consecutive was generally used interpreting from these individuals.
VENTURA SUPERIOR COURT Paras (Hall of Justice)	Same feedback as for Connected Justice above, with the difference that attorney/client conferences were done simultaneously over a phone with two handsets.

<p>Question 5: Overall what did each vendor do very well, do well but could do better, did not do well at all, considering ease of installation, quality of service [of VRI sessions], training, and support?</p> <p><i>Intent: To ascertain whether the vendor had a good solution, whether they learned important lessons from early pilot court installations and got better over time.</i></p>	
<p>MERCED SUPERIOR COURT Connected Justice (Los Banos)</p>	<p>I think Connected Justice did well on the installations and introduced latest equipment to the Court. There were call quality issues at the start of inter-court testing; however, these were resolved after extensive troubleshooting with the vendor/ISP. The live inter-court sessions were excellent quality.</p>
<p>MERCED SUPERIOR COURT Paras</p>	<p>Paras was responsive to issues that arose, and flexible in meeting the requests of our interpreters for equipment modifications.</p>
<p>SACRAMENTO SUPERIOR COURT Connected Justice</p>	<ul style="list-style-type: none"> i. Ease of installation: Connected Justice did not do well at all. We were shipped equipment without warning and never received a list of what equipment we should have. Some equipment was shipped to the wrong sites and we were requested to box up and re-ship the equipment to correct these mistakes. A plan of action was not communicated before arrival to the site. Installation took longer than planned for and required court staff to assist after business hours. Equipment was left in boxes and we were requested to secure the equipment. Some of this equipment remained unused for the duration of the pilot. Testing was not done thoroughly after installation and so problems were later discovered that required multiple trips. We had multiple equipment failures that delayed installation. The end result appeared sloppy, e.g., cable management was poor. ii. Quality of Service: Good but could have been better. The court staff and the interpreters were able to work through a process that worked for them, but the end result didn't take advantage of lots of the equipment that was installed. The equipment operation ended up being too complicated for court staff and interpreters to use during a court session. iii. Training: Did not do well at all. Training was conducted much too early in the installation process. The end result did not mirror what was trained, so lots of the training had to be repeated. Connected Justice would make modifications to the equipment without informing everyone and so it was not always clear how some things worked. iv. Support: Could have been better. We were given different contacts to use if there was an issue, but it wasn't always clear who to call for each different issue. We had a few issues

	that were never resolved – for example, the phones would power off and deregister and we were told it was due to our equipment or network wiring and they couldn't fix it.
SACRAMENTO SUPERIOR COURT Paras	<ul style="list-style-type: none"> i. Ease of installation: Well but could have done better; They relied a lot on our own knowledge of the devices and certain parts of the devices (the time display) never worked right, even after the issue was explained to them. ii. Quality of service: Very good; The VRI sessions worked well. iii. Training: Did well; Training was straightforward. iv. Support: Did not do well at all; As mentioned before a lot of the issues we had, especially early on, took many tries before they were corrected. Overall knowledge of the system seemed limited. Some issues that were reported were never corrected, and other issues were dismissed as not in their scope.
VENTURA SUPERIOR COURT Connected Justice (Oxnard)	Connected Justice approached the project with the demeanor that they were the experts. There were times when our ITU staff were at odds with their proposed configuration of our network. Exceptions were made in order to implement their design in a manner that was acceptable to our engineers. CJ presented themselves as very competent and businesslike; with a National client base. They were responsive to our interpreters needs and requests. Their configuration was more complex than the competitive vendors, but in the end was easier to use and preferred by our interpreters.
VENTURA SUPERIOR COURT Paras (Hall of Justice)	Paras was concerned with finding a solution for the exact needs of the Court. They were responsive at all phases of the pilot and they worked hard to resolve issues that came up.

VRI Questions – Vendor Responses

Minimum Technical Guidelines

Following are actual responses from the vendor to questions about meeting the technical requirements for the VRI pilot.

Question 1: What additional equipment, if any, was installed after the go-live date? <i>Intent: To ascertain whether the vendor had a good solution, whether they learned important lessons from early pilot court installations and got better over time.</i>	
CONNECTED JUSTICE	Los Banos <ul style="list-style-type: none"> • Sound Domes • Biamp TesiraFORTÉ DSP • Microphones
PARAS	No changes in video equipment. Changes were made in handsets and microphones to address audio issues that emerged and interpreter preferences.
Question 2: Specifics of head-end Cisco UC servers – Windows OS, Cisco software version, CallManager settings for each pilot court. <i>Intent: To determine whether the vendor was offering a current solution.</i>	
CONNECTED JUSTICE	TeleSpace provides the Connected Justice Cloud consisting of edge connectivity via VPN or Dedicated MPLS services, Cisco CUCM Call Control for any Cisco IP Phone, video codec or personal telepresence device. TeleSpace also provides PSTN services for direct dial in to appropriate endpoints. Lastly, the Connected Justice cloud consists of Cisco Contact Center Enterprise with detail call accounting and real-time queuing of interpreters and language profiles.
PARAS	Cisco HCS platform, CallManager version 11.
Question 3: What was the method of capturing/monitoring/reporting call quality, if any? <i>Intent: To ascertain whether the vendor could quantify the performance of their system in order to achieve/maintain high service levels.</i>	
CONNECTED JUSTICE	The POV never implemented calls between sites and thus calls were only local over customer local LAN and thus had no access to QoS or traffic shaping nor capture.
PARAS	Check call statistics from the video device. (call rate, fps, jitter, packet loss)

Question 4: How were problem reports of video pixilation and/or audio jitter fixed from technical side, e.g., was bandwidth increased, traffic shaped, QoS and/or CoS tweaked, resolution adjusted downward/upward, et cetera? <i>Intent: To determine whether the vendors and CCTC work together to understand and address service issues.</i>	
CONNECTED JUSTICE	The POV never implemented calls between sites and thus calls were only local over customer local LAN and thus had no access to QoS or traffic shaping nor capture.
PARAS	<p>Class of Service (to make sure sufficient bandwidth reserved for RT traffic) implementation is needed for the county court's access link to MPLS.</p> <p>Other tweaks made were not conclusive, the only definite fix was on the physical layer - make sure each hop of the access link (from switch port to firewall port to T1 / Ethernet) is error free.</p> <p>Bandwidth increase is needed based on traffic usage and number of concurrent calls. A T1 link (with CoS of 50% RT) is sufficient for 1 video call at 500kbps. For a 10Mbps access link to MPLS, the CoS implemented should be 20% RT.</p> <p>CallManager needs to setup the calls with the correct bandwidth: setup inter-court calls with 500 kbps, and intra-court calls can be as high as 3Mbps.</p>

Question 5: What were your qualitative/quantitative measures of a successful VRI session? <i>Intent: To obtain input on quality issues such as the video freezing or hearing an echo during the sessions. The quantitative factor would highlight the frequency of the issue.</i>	
CONNECTED JUSTICE	<p>Qualitative Observation, stakeholders input and JCC escalation of echo/delay experience on both Paras and TeleSpace lead to a new supported Cisco Connected Justice Version II architecture that requires only one audio path/plane with control to be supported moving forward. This was mostly driven by an interpreter getting headaches using the Paras system.</p> <p>Quantitative The needed data was not capture due to improper use and limited number of session per sites, Los Banos may be best capture of the experience with Oxnard second.</p>

PARAS	<p>Visual evaluation of an on-going call. Both video and audio quality is evaluated. Check call statistics (on the video device during a call) Expectation should be:</p> <ul style="list-style-type: none"> • 0.5% packet loss (both transmit/ receive) • 5 ms jitter (both transmit / receive)
--------------	--

Question 6: How was the performance of your solution for intra-court VRI sessions? For inter-court sessions?
Intent: To obtain feedback on intra-court sessions where the remote interpreter is in the same building as the court room or in a nearby court facility, where the network connection is usually stable. Inter-court sessions refer to sessions between different court, for example the Merced court using interpreter services at the Sacramento court.

CONNECTED JUSTICE	<p>Intra-court experience was good, minor issues were communicated but since all traffic was local and we had no access to the customer LAN to implement QoS most traffic was best effort.</p> <p>Inter-court traffic was tested during implementation but site to site was not utilized during POV. All sites had a public internet edge thus only best effort, which was acceptable if the public edge had a large up and down speed ISP provider.</p>
--------------------------	--

PARAS	Call quality was evaluated by JCC staff and found acceptable.
--------------	---

Question 7: Did court interpreters provide constructive feedback on vendor-installed equipment? Please describe any changes made based on this feedback, e.g., using different webcams, higher/lower resolution, touchscreen displays, headphones, microphones, courtroom PA systems, laptops, etc.
Intent: To determine whether primary users of deployed solution provided the vendors with initial and ongoing feedback to make the elements work better together.

CONNECTED JUSTICE	<p><u>Input</u> Input was collected before, during and after the POV to include knowledge gain from working other states and Federal courts. Ideas were tested during the POV which allow us to validate user concerns, while these changes did not always meet the goal, it allowed us a deeper understanding of the real issue.</p> <p><u>Demonstration</u> The use of different direction sound technology on the market as headsets not only induced hygiene concerns, but time, required to manage and exchange headsets between LEPS.</p> <p><u>Sound</u></p>
--------------------------	---

	Hearing, being heard and delay/echo was the biggest issue, at least, the largest concern messaged during the CA POV. Many patches/concepts were implemented during the POV, however; none corrected all the issue, at best, only masked the issues addressed.
PARAS	Court interpreters and court staff were active in making suggestions for improving the user experience. The judicial officer in Sacramento requested a second video device on the bench so that they could view the interpreter while facing the defendant. Interpreters requested a change in the microphone set up so that they could mute the device to the courtroom more easily. Several different headphones and headsets were changed in the courtroom to decrease audio feedback to the interpreters.

Question 8: Did the vendor have out-of-band (OOB) access to their installed network devices? <i>Intent: To determine whether the vendor could perform troubleshooting without dispatching technicians on-site.</i>	
CONNECTED JUSTICE	Support was provided by the customer using WebEx and sharing their desk top when device was on their LAN, CJ devices could be access directly if on the TeleSpace VLAN.
PARAS	No.

DRAFT

VRI Questions – Vendor Responses

Findings Report and Recommendations

Following are actual responses from the vendor to questions about their experiences and observations over the course of the VRI pilot.

<p>Question 1: Was interpreter’s office or working space able to comfortably accommodate your equipment? Was privacy ensured? Was network infrastructure from interpreter’s office to courtroom sufficient to perform VRI sessions?</p> <p><i>Intent: To ascertain whether the courts provided adequate facilities for vendor equipment, interpreters and the unique demands of remote video interpreting. Facilities would include lighting, ventilation, soundproofing, network drops, and work space.</i></p>	
<p>CONNECTED JUSTICE</p>	<p>Was interpreter’s office or working space able to comfortably accommodate your equipment? Yes.</p> <p>Was privacy ensured? Yes.</p> <p>Was network infrastructure from interpreter’s office to courtroom sufficient to perform VRI sessions? Yes, except for Sacramento as they had network issues between the court house and interpreter’s office.</p>
<p>PARAS</p>	<p>The interpreter workspace was able to comfortably accommodate the equipment, although the interpreter workstation rooms in Sacramento were small and probably not sufficient to offer a space for an interpreter to work all day.</p> <p>In each location, the interpreter workstations were located in rooms with doors that closed and were private settings.</p> <p>Yes, the network infrastructure from interpreter’s office to courtroom is sufficient to perform VRI sessions.</p>

Question 2: How many consecutive interpretations were performed? How many were simultaneous? Were there technical issues that discouraged either type of interpretation? <i>Intent: To determine whether the remote interpreters were able to perform both types of interpretations using the vendor's solution.</i>	
CONNECTED JUSTICE	How many consecutive interpretations were performed? All as this is the mode the interpreter starts in. How many were simultaneous? No data was collected. Were there technical issues that discouraged either type of interpretation? Yes, muting and un-muting was hard to grasp for some interpreters.
PARAS	In testing mode, 1 consecutive interpretation (using 2 concurrent video calls) was performed. 5 concurrent video calls were tested between Sacramento and Ventura, calls video quality was acceptable. Information regarding the number and type of call during regular court sessions is only available from the local court teams.

Question 3: Training on vendor equipment – was it effective, did it take repeated training sessions to use the equipment correctly? <i>Intent: To determine whether the implemented solution was simple or complex for the court users to operate it effectively.</i>	
CONNECTED JUSTICE	Yes, all sites the interpreters were engaged, wanting to learn with Oxnard showing extended support.
PARAS	Training for courtroom staff regarding how to use the video equipment was very simple and straight forward. Training for interpreters required some practice for the interpreters to feel comfortable adjusting the camera view in the courtroom and switching between addressing the courtroom or the defendant.

Question 4: Given a state government network, was it difficult to install your site-to-site VPN tunnel to the CCTC? <i>Intent: To determine if vendor employed enterprise-grade VPN endpoints that are compatible with Cisco hardware used by the CCTC.</i>	
CONNECTED JUSTICE	Yes at some sites depending on their security prospective, but doable over time.
PARAS	The VPN tunnel was not difficult to install.

Question 5: Given a state government network, was it difficult to connect to CCTC WAN? <i>Intent: To determine if vendor employed enterprise-grade VPN endpoints that are compatible with Cisco hardware used by the CCTC.</i>	
CONNECTED JUSTICE	[No response given]
PARAS	It was not difficult to connect to the CCTC WAN.

Question 6: How timely or difficult was it for you to tweak configurations after performance issues were reported? <i>Intent: To ascertain whether the vendor had processes and tools in place to satisfactorily deliver quality videoconferencing services to a state government agency.</i>	
CONNECTED JUSTICE	Oxnard and Los Banos had strong supportive staff.
PARAS	It was easy for us to tweak configurations on the CallManager side to troubleshoot performance issues. It takes a bit longer for AT&T to change the CoS settings on the MPLS access links. It took a longer time to figure out the performance issue was caused by network physical layer error (which is local at Merced site), once figured out, it was a quick fix.

DRAFT

Appendix A - VRI Implementations by Court

Following are graphics and photographs showing the actual implementation of the VRI solutions at the various court locations.

DRAFT

Appendix A1: Merced Implementation

DRAFT

Appendix – Merced Implementation

Paras and Associates Solution

Equipment Implementation in Courtroom 9

Remote Interpreter Station



Media Cart in Courtroom

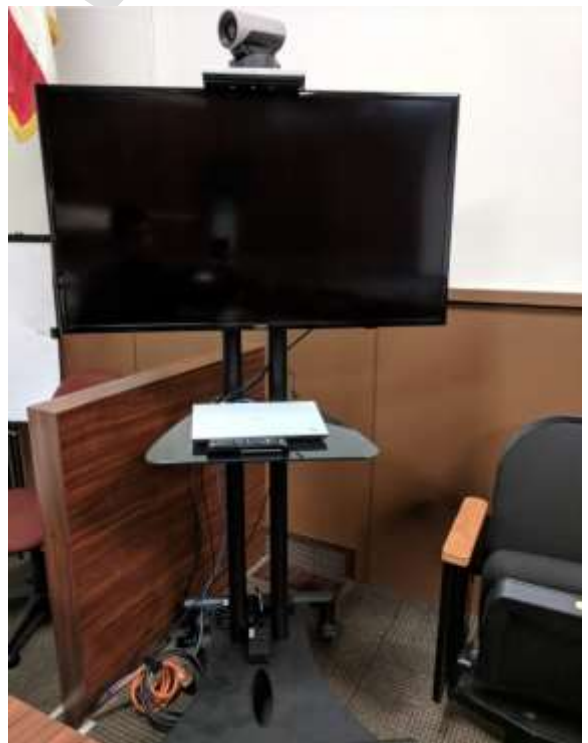

LEP Station



VRI Helpdesk

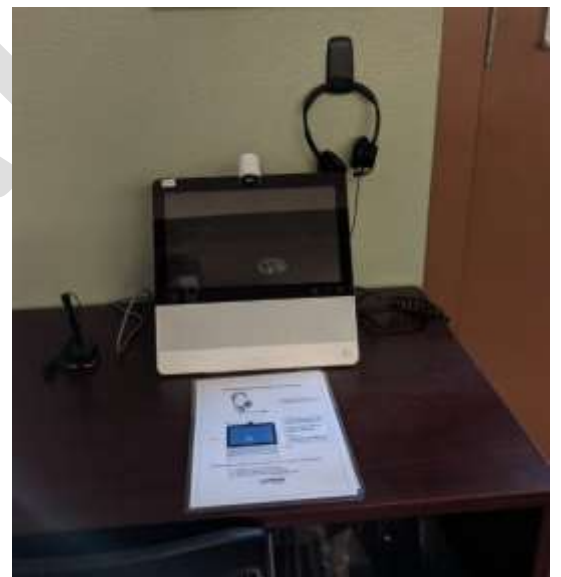
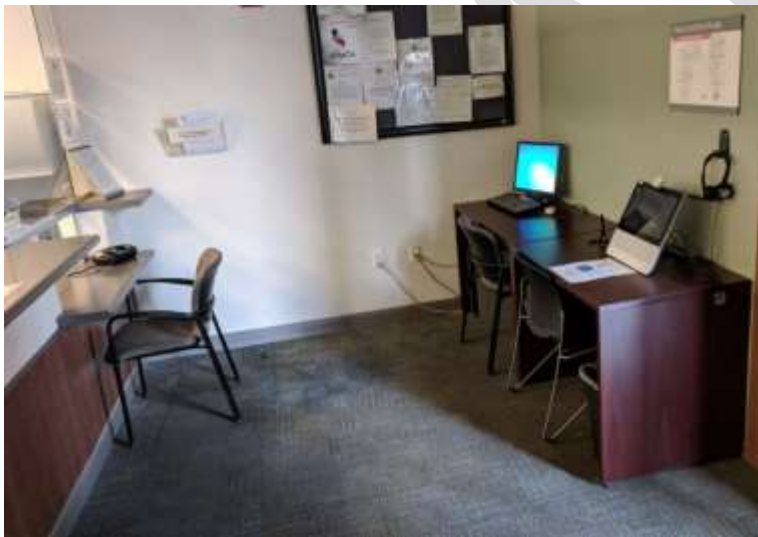

VRI Network Implementation using CCTC

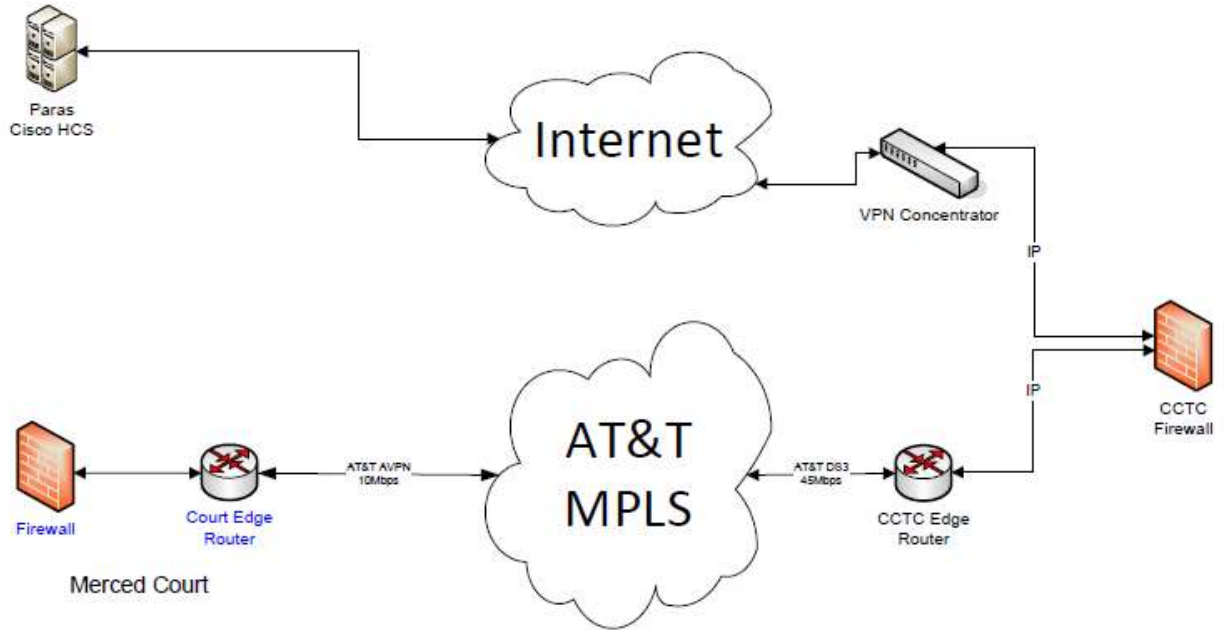

Connected Justice Solution

Equipment Implementation in Los Banos

Remote Interpreter Station



VRI Cart in Courtroom



LEP Station



Vestibule Hallway



Interview Room



Jail Side



Attorney Side

Dome Microphones and Speakers



Courtroom/Litigant Area



Inmate Arraignment Area

VRI Helpdesk/Document Room



Los Banos VRI Network Implementation

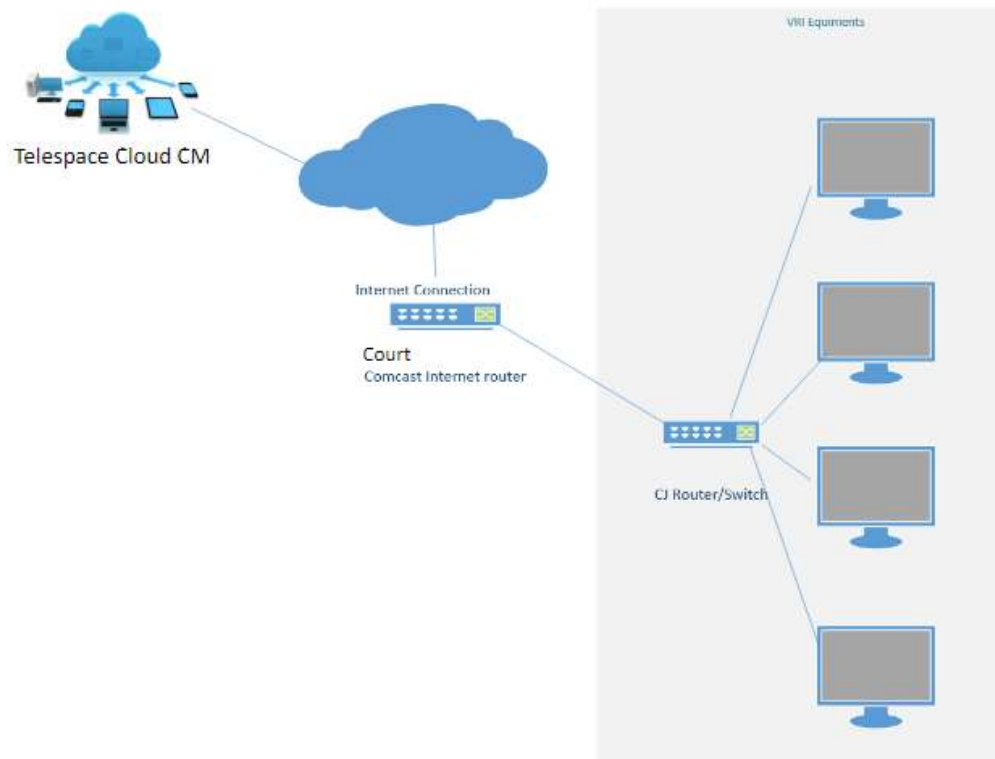

Appendix A2: Ventura Implementation

DRAFT

Appendix – Ventura Implementation

Paras and Associates Solution

Equipment Implementation in Courtroom 10

Remote Interpreter Station



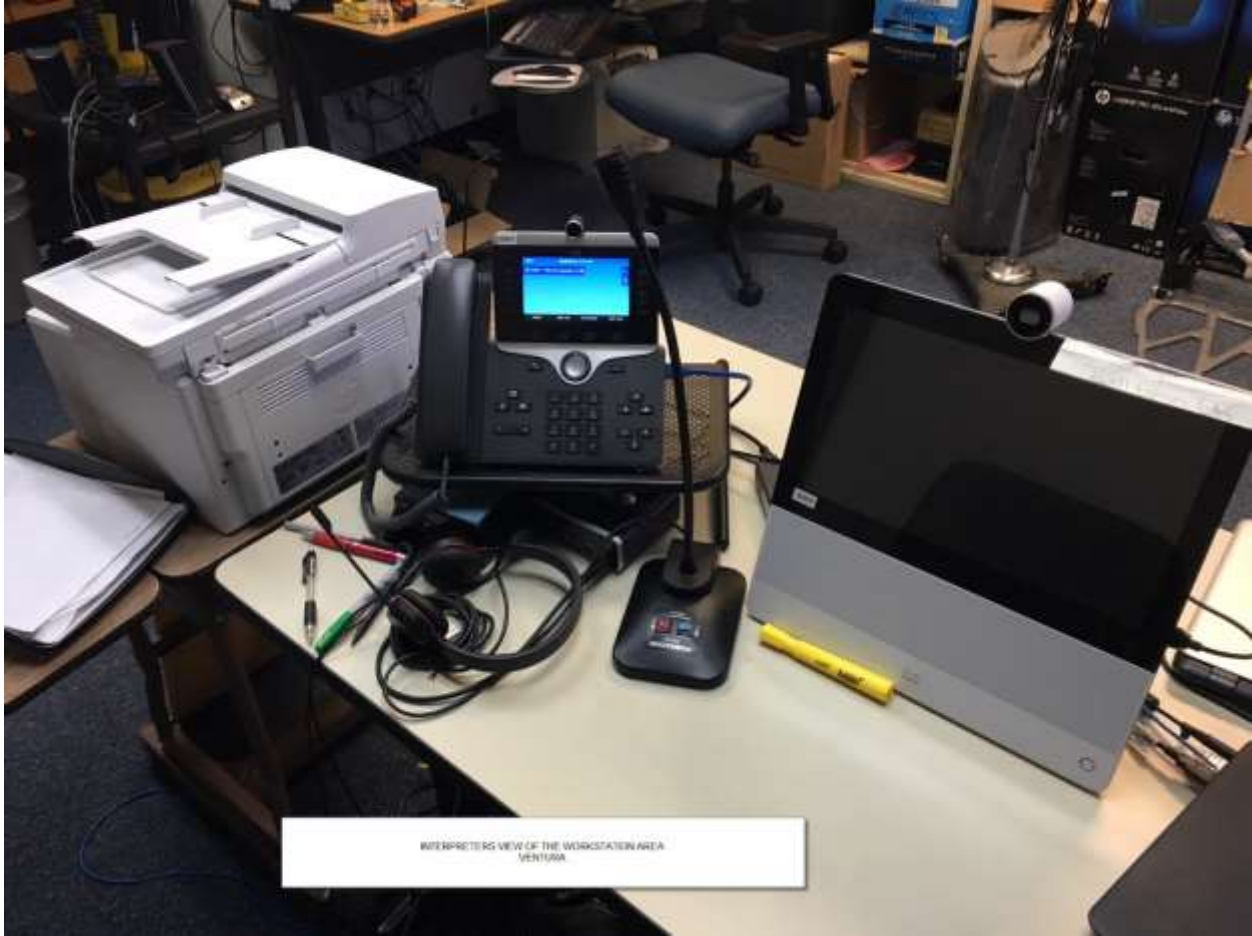

INTERPRETERS VIEW OF THE WORKSTATION AREA
VENTURA

DR



SIDE-VIEW OF WORKSTATION AREA
CLOSE-UP OF SCANNER PRINTER
VENTURA

DRAFT

VRI Cart in Courtroom





SIDE VIEW OF MAIN CART (VENTURA CR-10) SHOWING AUDIO MIXER USED TO CONTROL COURTROOM PA SIGNAL ENTERING CODEC



CLOSE UP OF CISCO SX-20 CODEC IN VENTURA CR-10

LEP Station

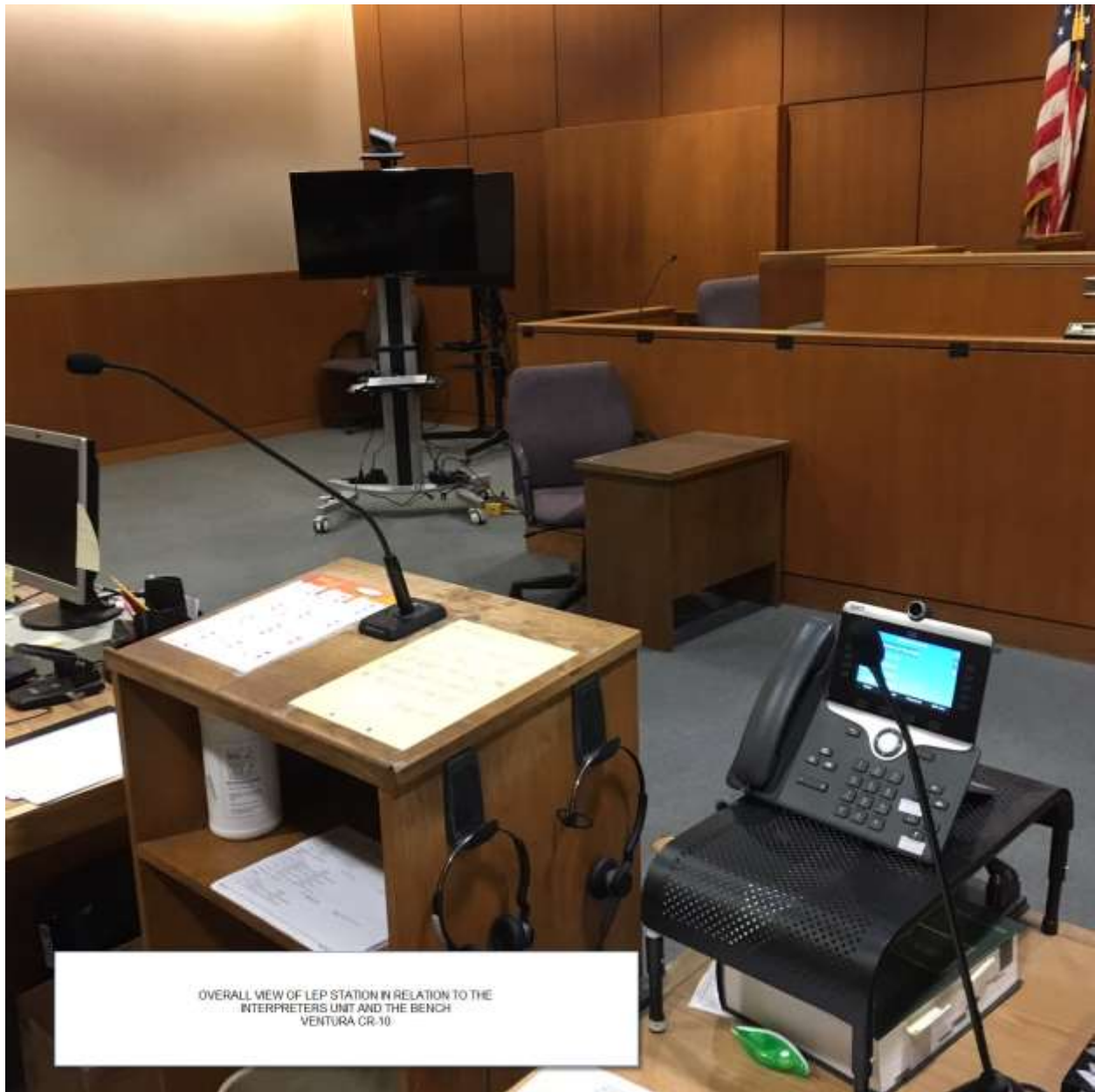

OVERALL VIEW OF LEP STATION IN RELATION TO THE
INTERPRETERS UNIT AND THE BENCH
VENTURA CR.10



CLOSE UP OF THE LEP STATION
CISCO 8805 VIDEO PHONE
VENTURA CR-10

Interview Station



Miscellaneous

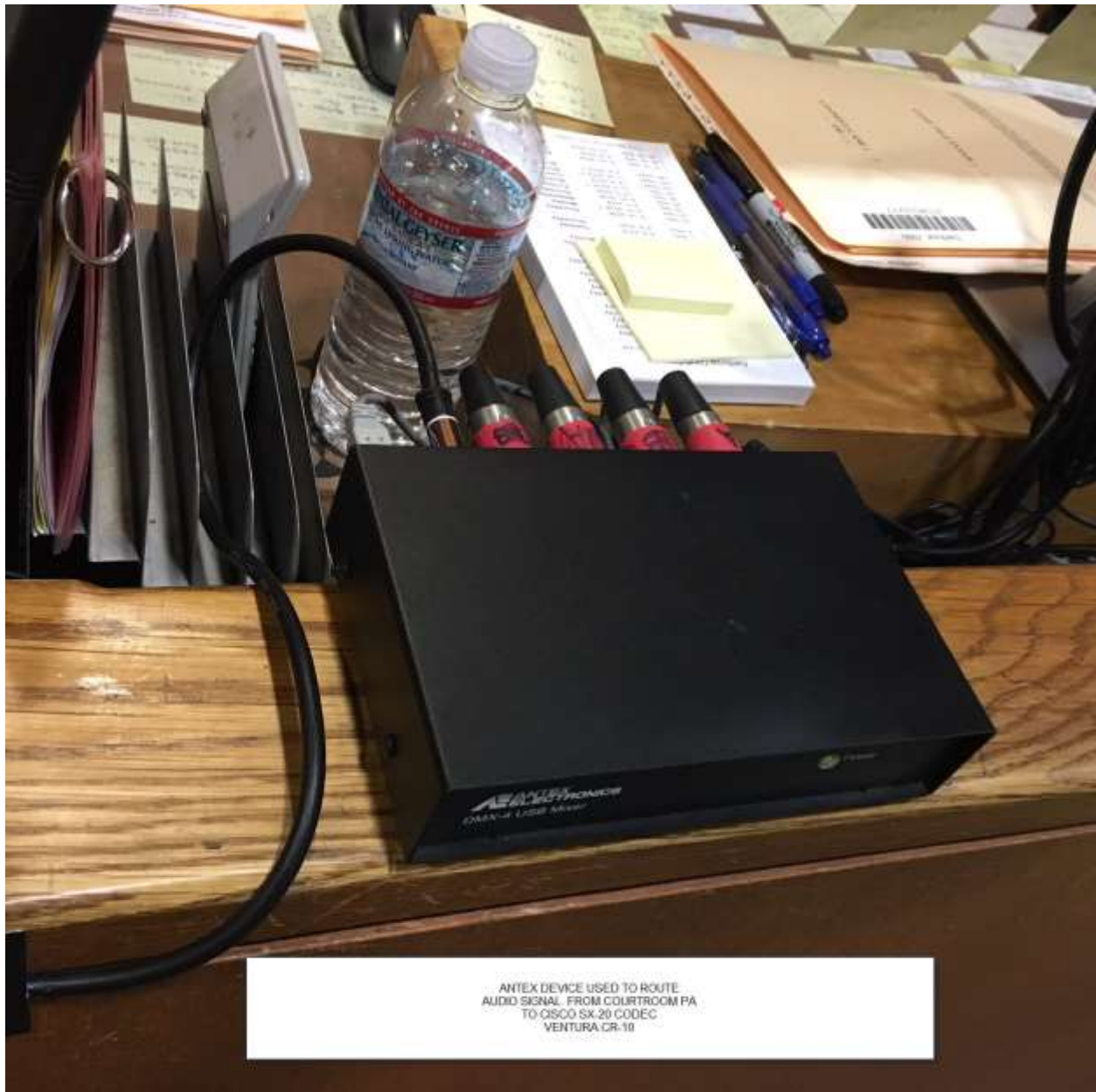

VRI Network Implementation using CCTC

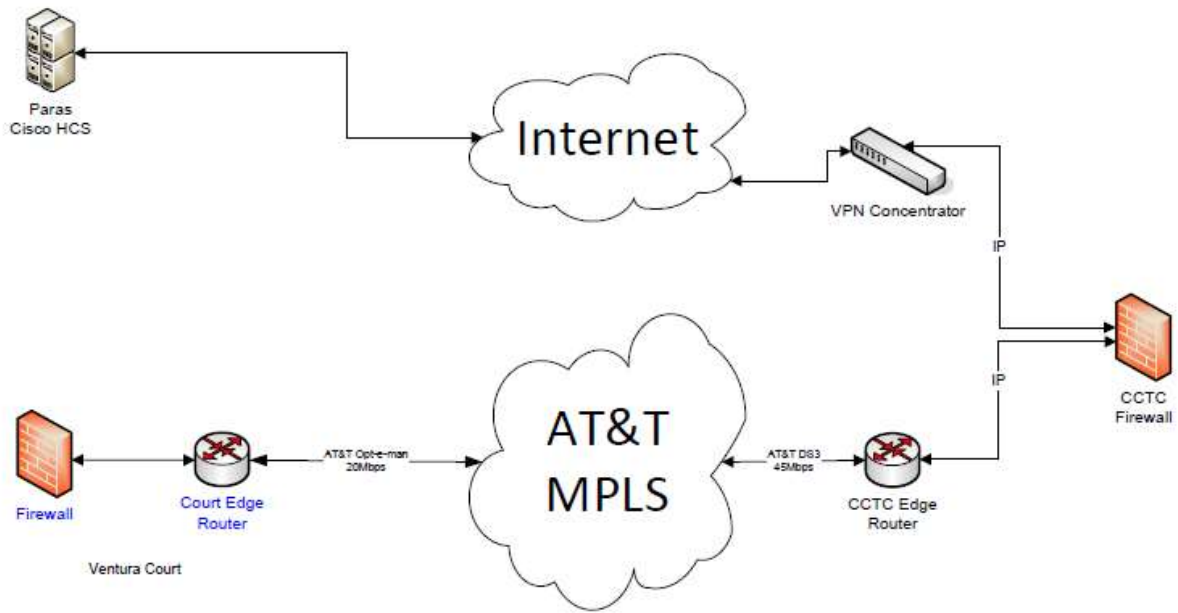

DRAFT

Connected Justice Solution
Equipment Implementation in Oxnard
Remote Interpreter's Office

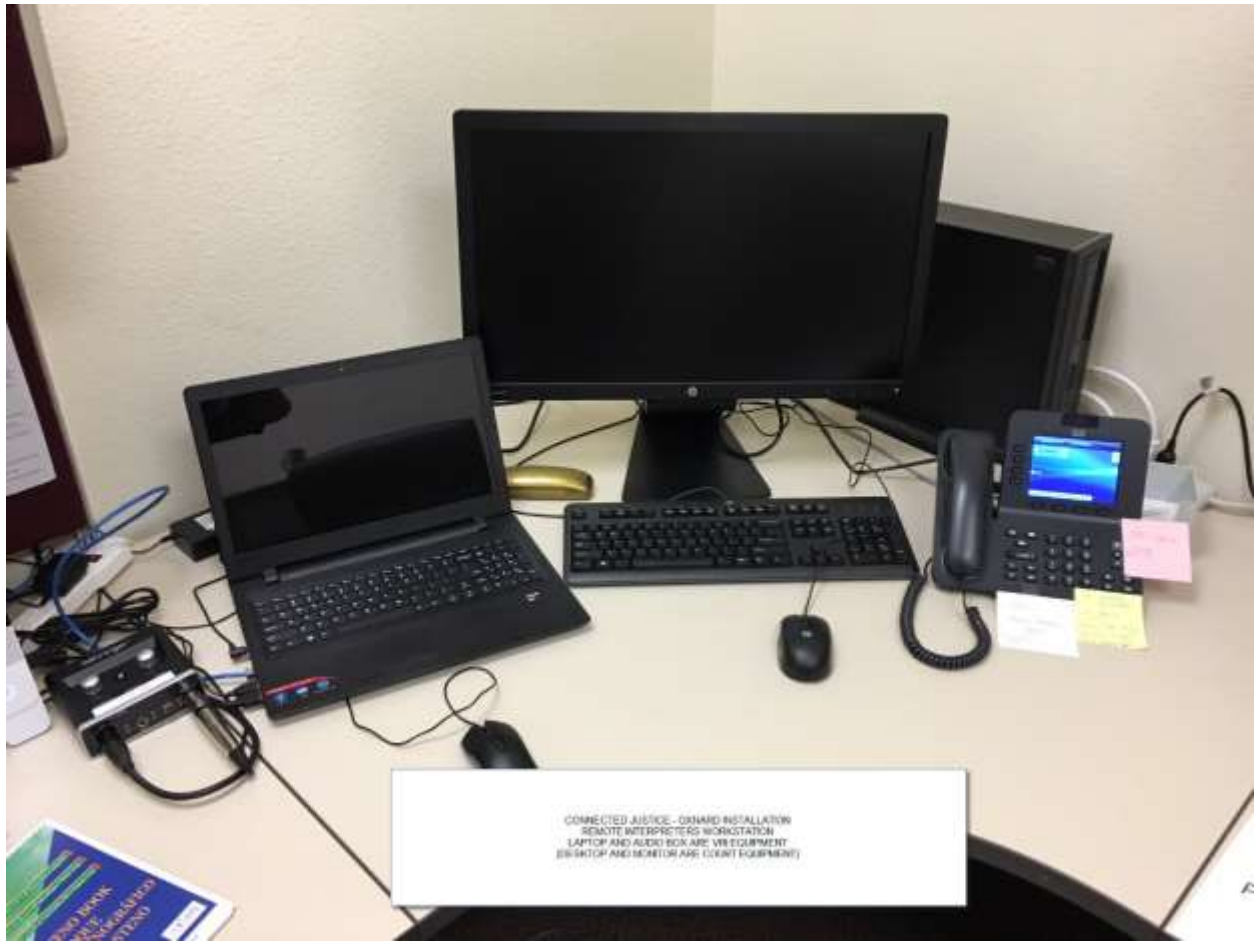



DR

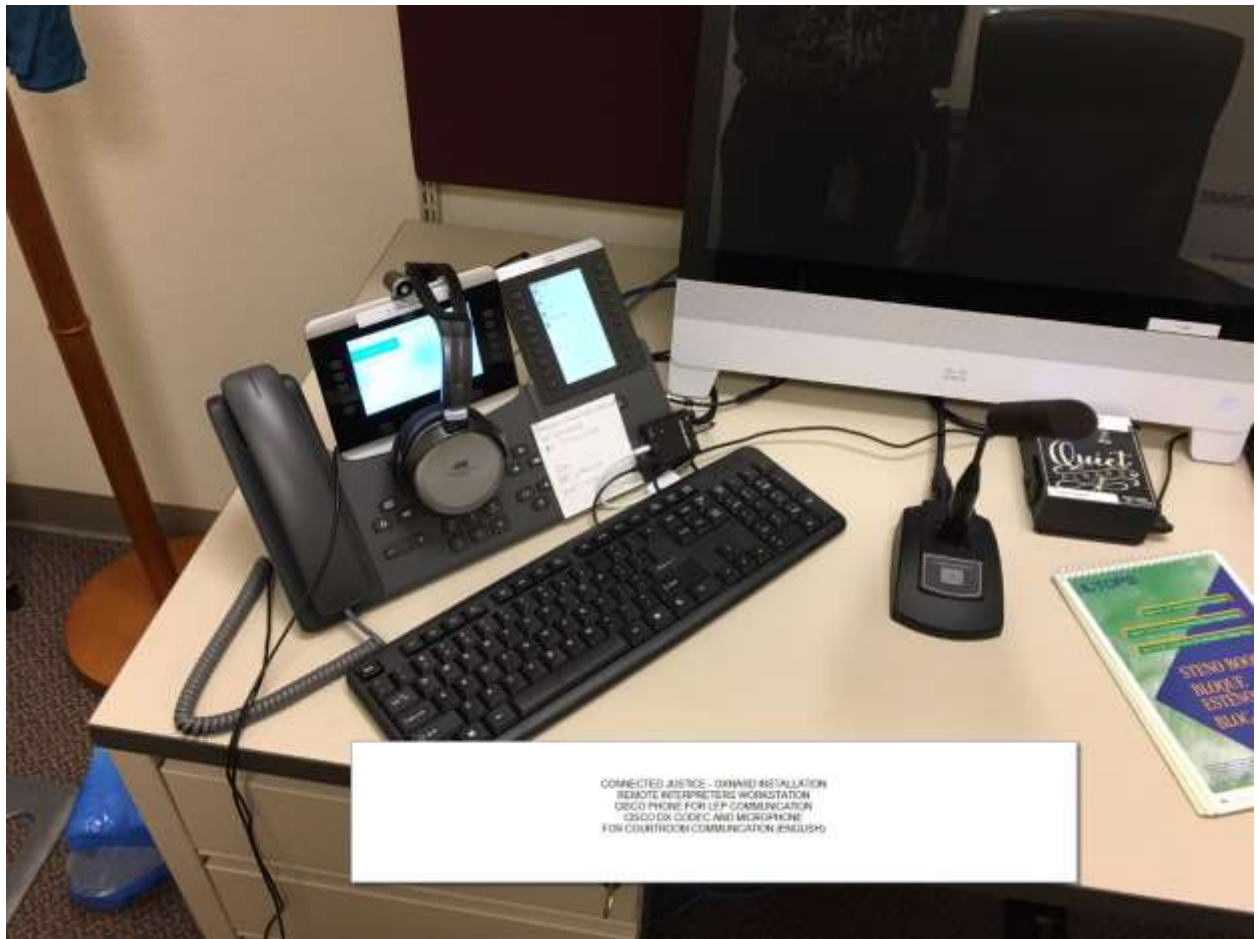

CONNECTED JUSTICE - ORNARD INSTALLATION
REMOTE INTERPRETERS WORKSTATION
DESK PHONE FOR LIP COMMUNICATION
CS/CO EX CODEC AND MICROPHONE
FOR COURTROOM COMMUNICATION (ENGLISH)

DRAFT

VRI Cart in Courtroom



CONNECTED JUSTICE - OXNARD INSTALLATION
COURTROOM WORKSTATION CISCO SX CODEC
CISCO PHONES FOR LEP COMMUNICATION
WIRELESS UNITS FOR INTERPRETIVE LISTENING
WOLFVISION DOC CAMERA FOR EVIDENCE PRESENTATION

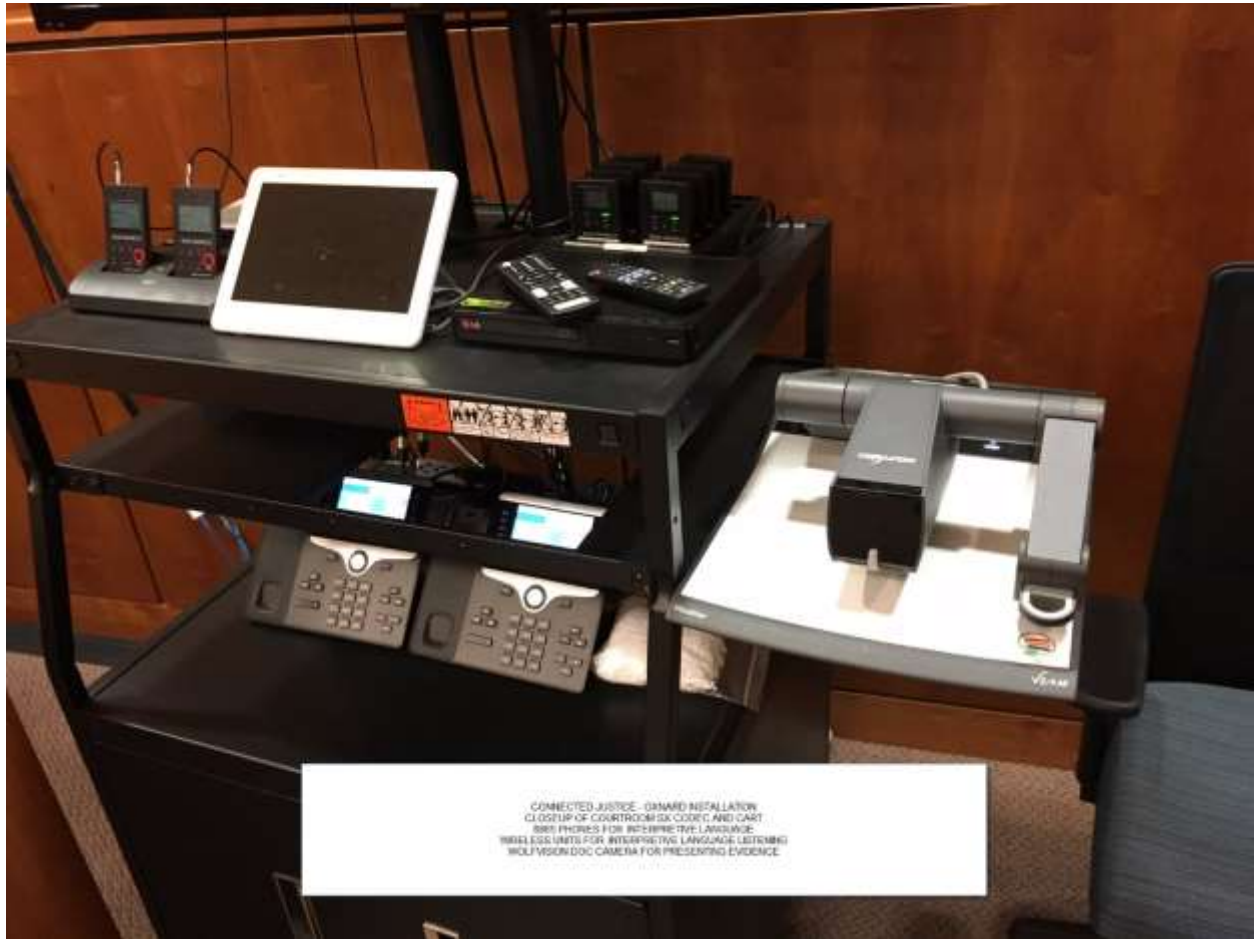

CONNECTED JUSTICE - OSNARD INSTALLATION
CLUSTER OF COURTROOM EX CODEC AND CART
BRIE PHONES FOR INTERPRETIVE LANGUAGE
WIRELESS UNITS FOR INTERPRETIVE LANGUAGE LISTENING
WOLFVISION DOC CAMERA FOR PRESENTING EVIDENCE

DR

Judge's Bench

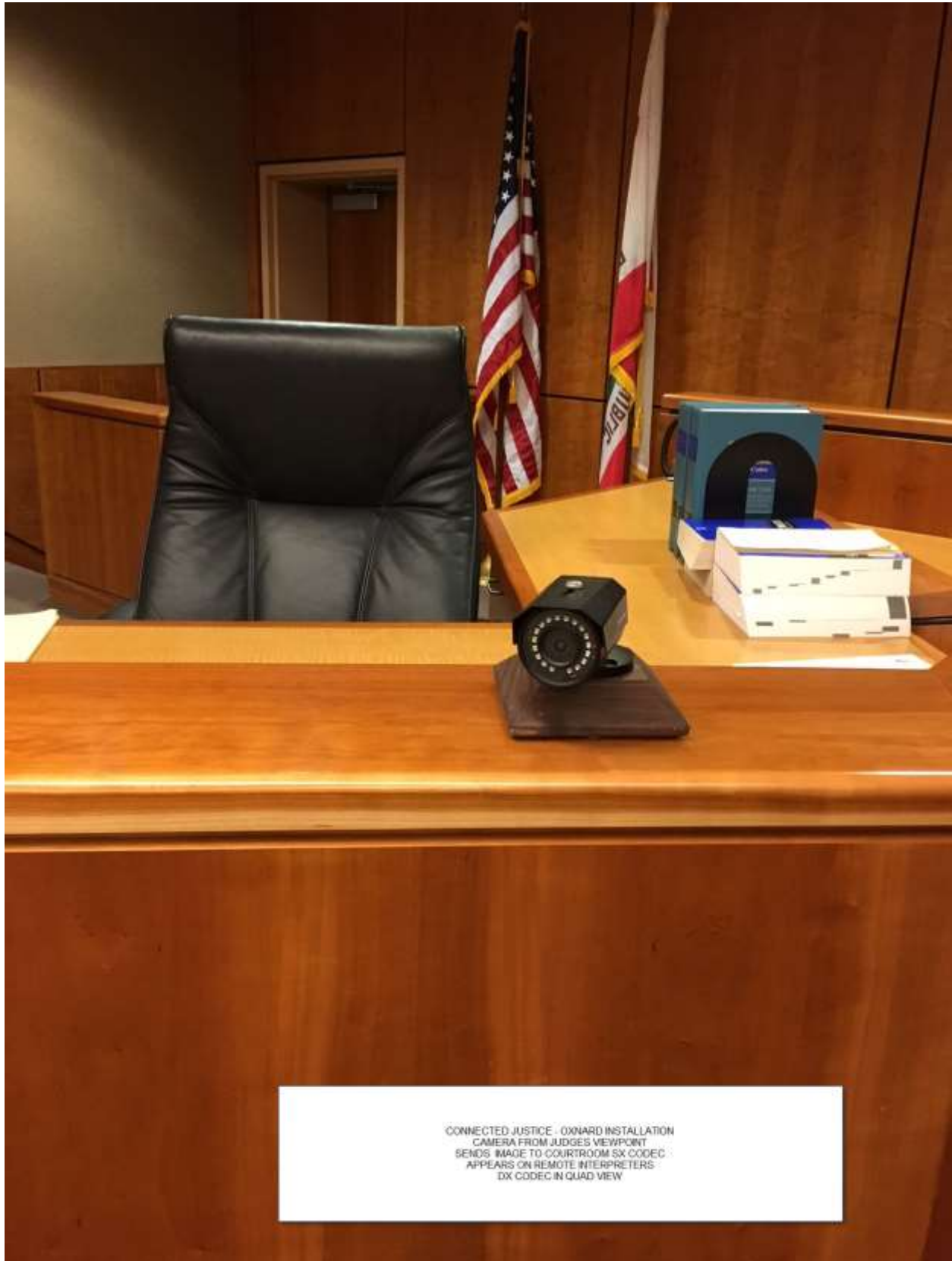

Clerk Station

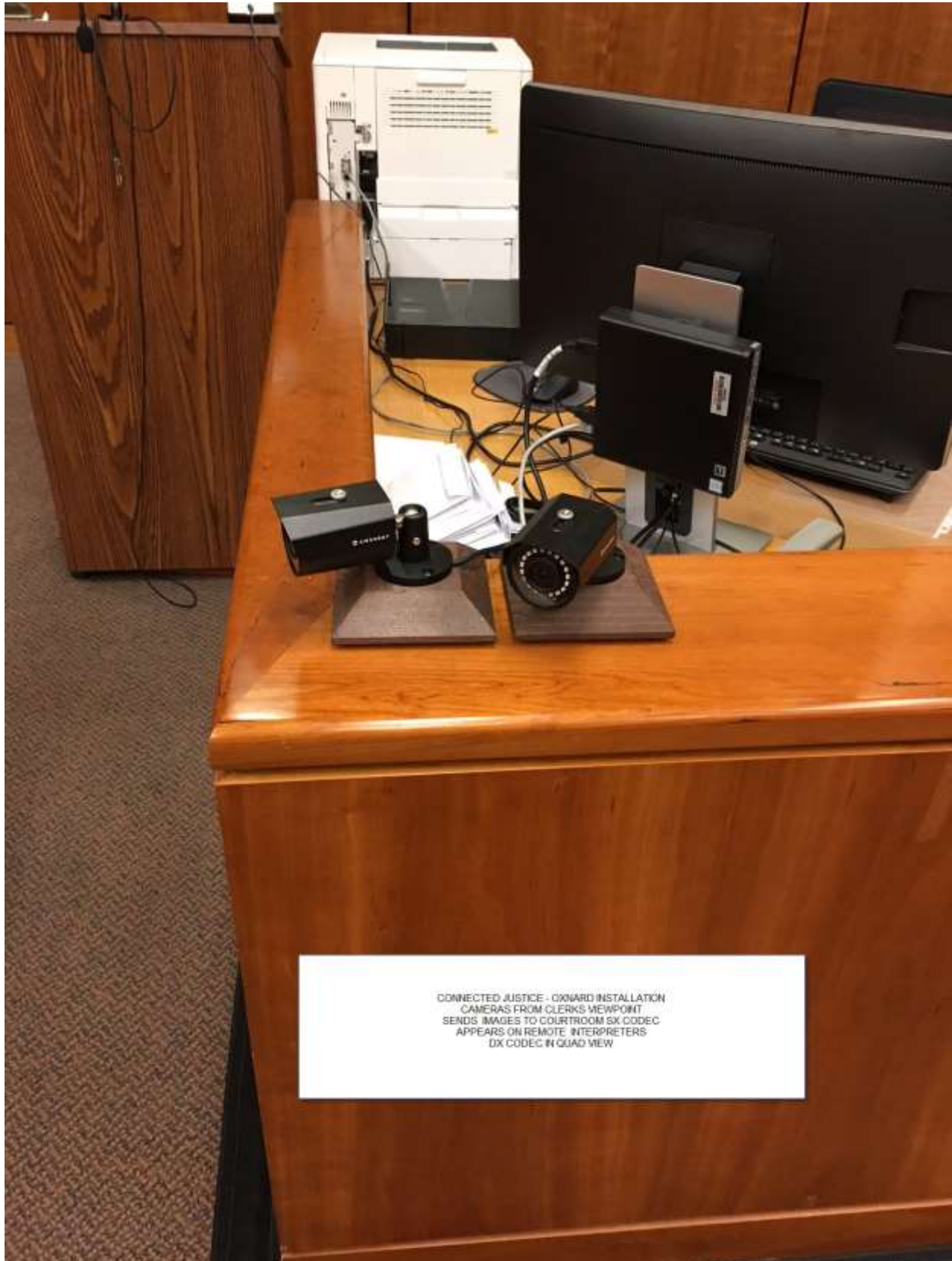

CONNECTED JUSTICE - OXNARD INSTALLATION
CAMERAS FROM CLERKS VIEWPOINT
SENDS IMAGES TO COURTROOM SX CODEC
APPEARS ON REMOTE INTERPRETERS
DX CODEC IN QUAD VIEW

LEP Station





DRK

Oxnard VRI Network Implementation

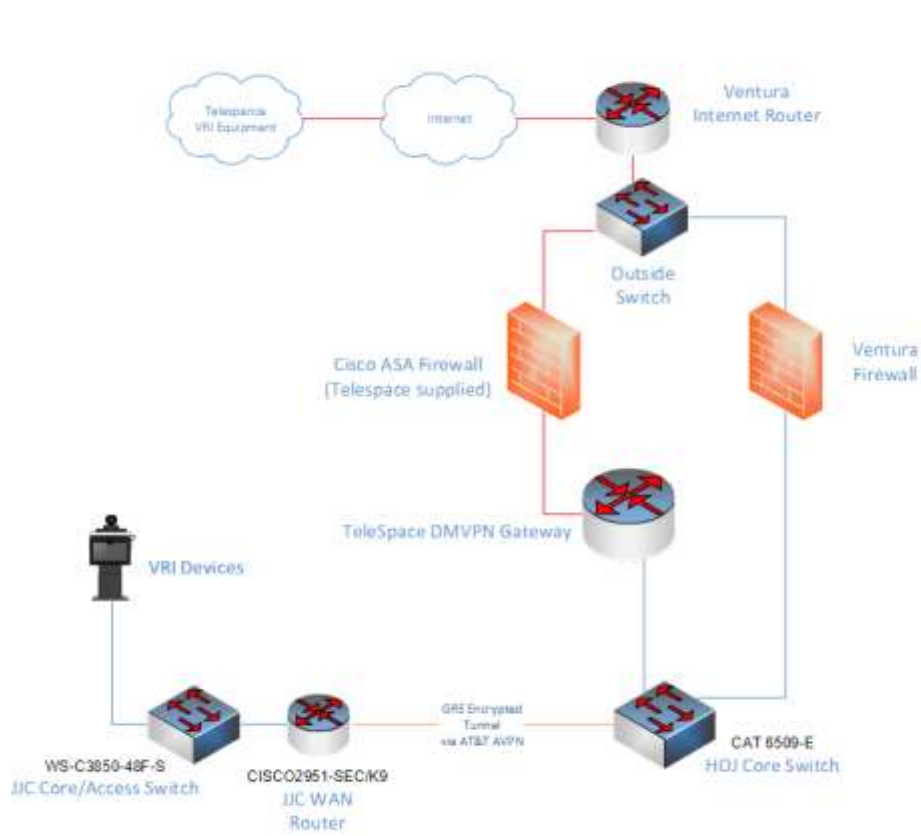

LAB:
Ventura-Connectivity Design
11/20/2017

VPN Tunnel ———
Layer 2 VLAN ———
GRE Tunnel ———

Ventura to create a layer 3 VLAN at JJC to attach the VRI equipment. Helper address will be needed on the interface for DHCP, DHCP to be configured on the MS Server. (No VRI equipment housed at HDJ)

Traffic from Telespace is via the DMVPN router and is encrypted all the way to the Telespace DMVPN Gateway.

Telespace to provide all IP's which are to be allowed inbound in order to create the appropriate ACL's on the Cisco ASA.

DR

Appendix A3: Sacramento Implementation

DRAFT

Appendix – Sacramento Implementation

Paras and Associates Solution

Equipment Implementation in Main Jail House

Remote Interpreter Station



Overview of station. Equipment from left to right: Headset with built in microphone, Cisco video phone, headphone splitter (under the phone), DX80, microphone connected only to the DX80, mixer.

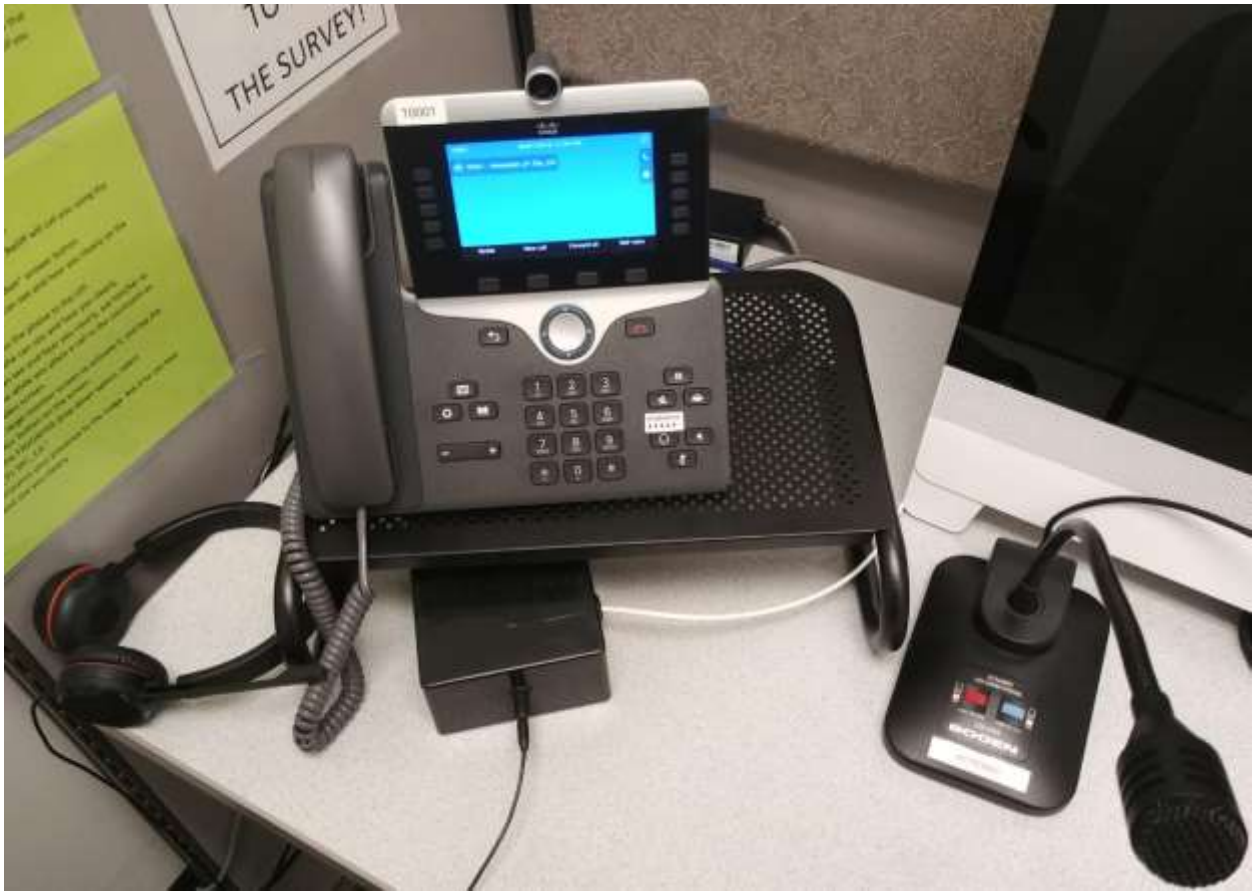

Picture of phone. Phone used to connect to the private line with the LEP, which was a second Cisco phone in the courtroom. The headphones on the headset were connected through the mixer to both the phone and DX80 for sound. The microphone on the headset was only connected to the phone. The splitter assisted with this and was provided by Paras.



Mixer. Used to connect to a microphone to the DX80 and to allow the headset to hear the sound coming from the DX80.

Courtroom Overview



Overview of Courtroom. Equipment from left to right: LEP station with Cisco phone and two handsets, Wireless microphones at counsel table. Microphone and mini screen on bench. Courtroom monitor and camera with SX20.

VRI Cart in Courtroom

Detailed view of SX20 cart. Equipment from top to bottom: SX20 main camera providing view of entire courtroom. Monitor providing view of interpreter for courtroom. Three wireless microphone receivers with mixer on the right. SX20 on bottom.





Detailed view of microphone equipment. This equipment was not provided by Paras and Associates, but was installed to accommodate them. On the right are three wireless microphone receivers. On the left is a mixer. There are 4 inputs into the mixer, one from each wireless mic and one from the bench mic. Two outputs are visible, one goes to the SX20 and the second goes to the courtroom speaker.

LEP Station



Detailed view of LEP table. Table would be moved into place on the left side of the courtroom near the “cage”. Two handsets were attached to the phone for private conversations with LEP and counsel. Two wireless microphones are visible, but were only placed there for storage, they would each be moved to the counsel table for use. The SX20 remote can be seen. This would allow the bailiff to answer incoming calls.

Judge's Bench

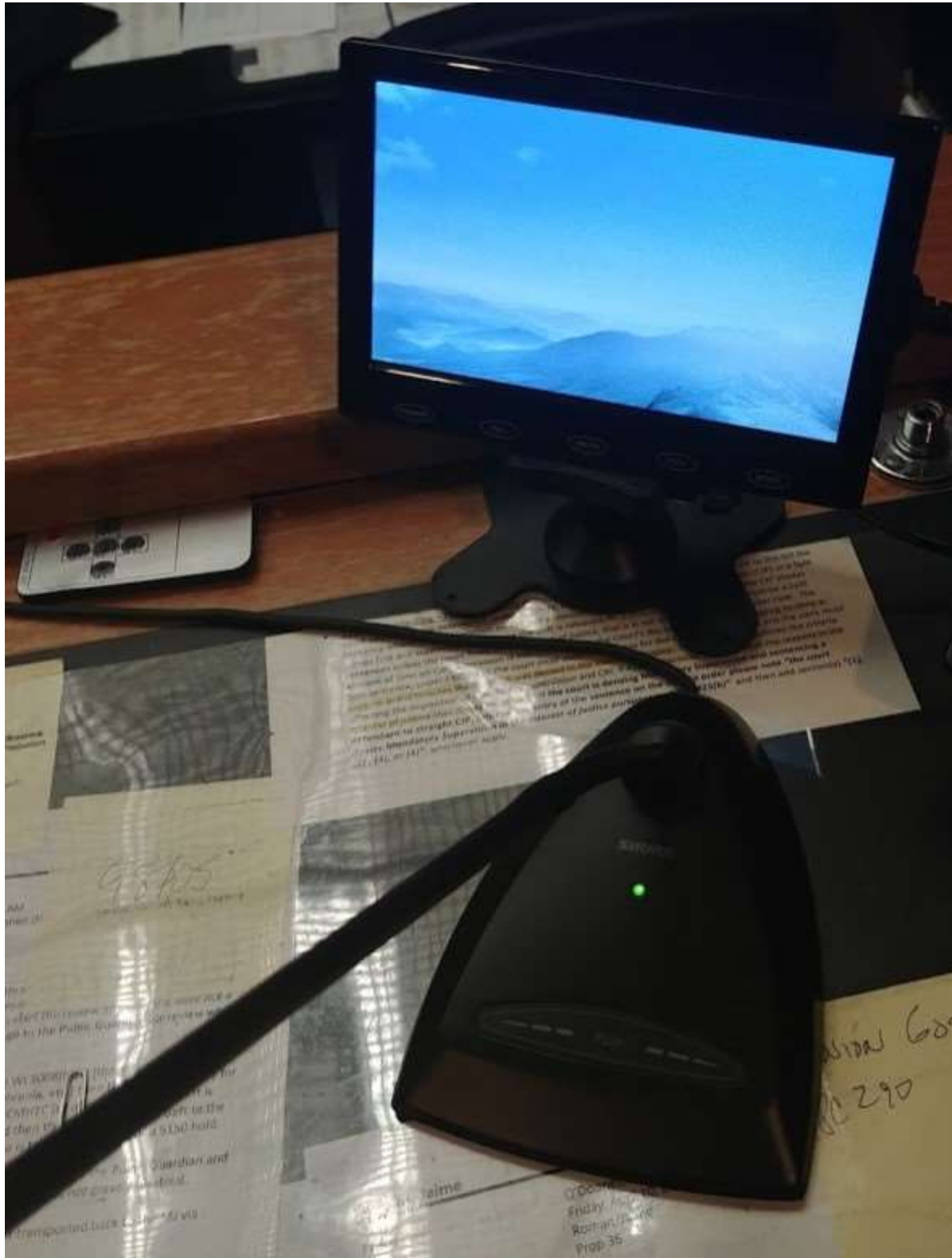

Detailed view of Bench. Small monitor attached to SX20 for Judge's view of interpreter. Microphone for Judge.

VRI Network Implementation using CCTC

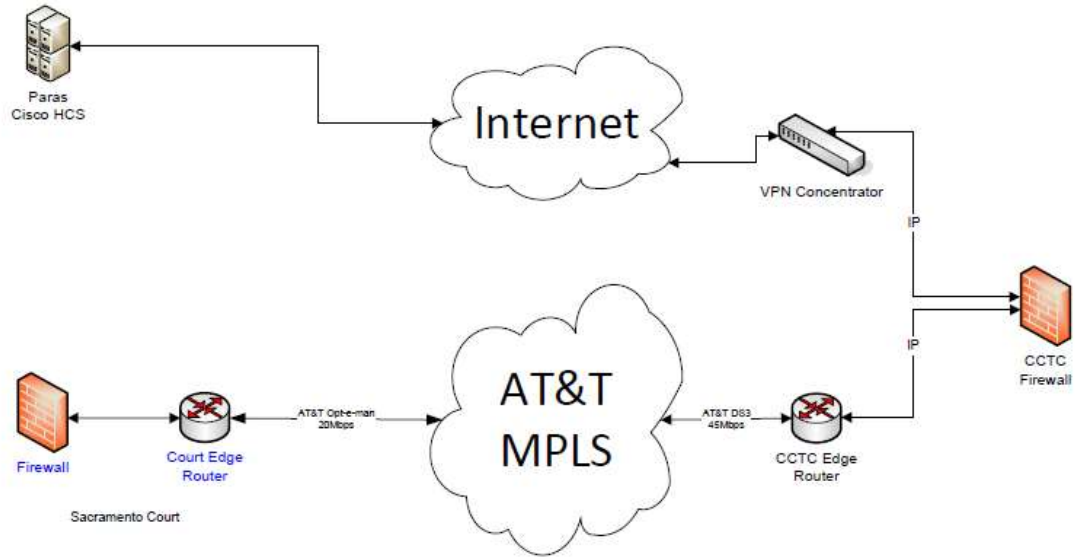

Connected Justice Consortium Solution
Equipment Implementation in Carol Miller Justice Center
Remote Interpreter Station



Overview of Interpreter station. Equipment from left to right: Cisco video phone with key expansion module, headphones, single microphone connected to phone and DX80, DX80, microphone “dead switch”, laptop, and mixer. The laptop was used to connect to the TeleSpace website. Laptop display was forwarded to the DX80.



Detailed look at mixer. Mixer was used to allow a single microphone to be used on both Cisco phone and DX80.



Detailed look at Cisco video phone. Phone was used to dial into courtroom “dome” for LEP to hear. DX80 was used to dial into SX20 for whole courtroom to hear. On the right is a secondary mixer for the headphones, with a line out coming from the phone and DX80.

Courtroom Overview



Overview of courtroom. Equipment from left to right: speaker dome, microphones, camera, red light station, SX20 with stand, speaker on tripod stand with cameras mounted.



Close-up of speaker dome, mounted to the ceiling. LEP would stand under the dome to hear private conversations from interpreter. Interpreter would dial into the dome from the Cisco phone in the interpreter's office.



Speaker for projecting sound to courtroom. DX80 would dial into the speaker. Cameras were mounted on top of the speaker for full view of the courtroom. A second speaker was located underneath the bench for the Judge to hear.

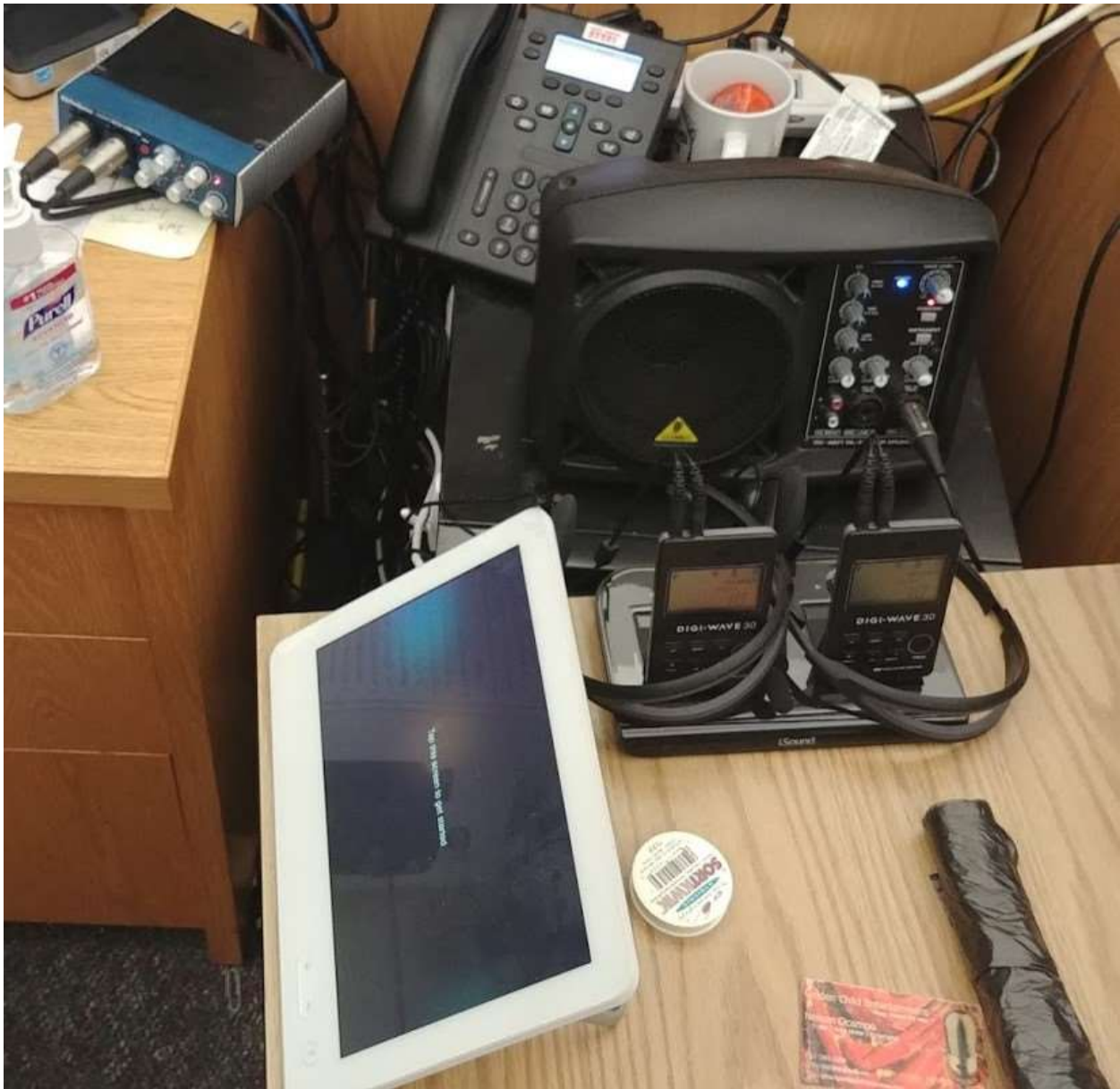

Courtroom control area (this is directly to the right of the Red Light video viewing area). Mixer on the top left for volume control, the touch panel is connected to the SX20 for answering when the interpreter calls into the courtroom. Two wireless headsets are visible for audience members to be able to hear the interpreter more clearly if necessary.

LEP Station



Station for Red Light camera video viewing. The DX70 would connect to the Interpreter station. A screenshare was connected to the desktop computer so the interpreter could view the video as well. Microphones and headphones were provided for private conversations.



Back of Red Light video station. A rear-mounted mixer is visible to accommodate the speakers and headphones.

VRI Cart in Courtroom



Side view of media cart. Equipment from left to right: document viewer on counter, wireless headsets in charging stations, camera for SX20, courtroom monitor, video converter, SX20, second monitor, and Cisco phone.



Detailed view of back of monitor. Equipment visible: HDMI receiver used to receive HDMI inputs from cameras, HDMI combiner used to combine HDMI signal and send to SX20.



Detailed view of document viewer. Document viewer is connected to SX20.



Detailed view of wireless listening devices. Devices on the left are receiving only. Devices on the right can send and receive (microphones can be attached but are not currently attached).



View of Cisco phones. Three phones were used for courtroom operations. One is connected to the dome, one is connected to wireless headsets and one is connected to wireless headset transmitter/receivers. The wireless transmitter/receivers would be used for private conversations. Interpreter station has ability to call each phone separately.



View of inside the media cart. Equipment from left to right: UPS, Biamp DSP, separate sound amplifier, Cisco networking switch.

Judge Station



Camera and microphone on the bench. These were connected to the SX20.



Bench view of the SX20. Two monitors were connected to the SX20, one for the bench and a second for the courtroom.

DRAFT

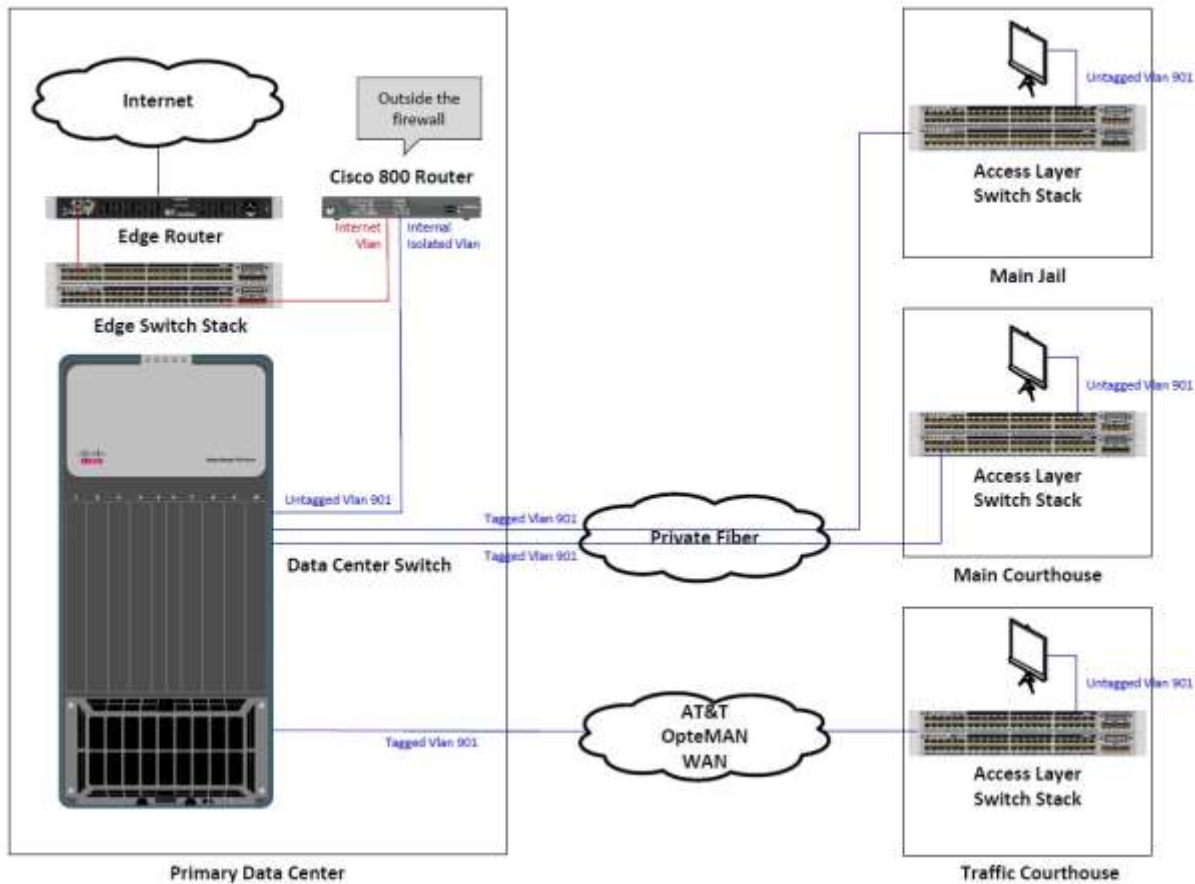

The Cisco 881 router was provided by Connected Justice and configured by them as a DMVPN router.

The 881 router is directly connected to our Internet router via the edge switch stack. This means it is in parallel with our edge firewalls. The internal interface is connected to the remote sites via a Layer 2 VLAN (nothing is routed internally). Just think of a switch and long extensions to the other sites/endpoints. No traffic traverses our firewalls.

The 881 router hands out its own DHCP lease and is the Layer 3 device for VLAN 901. None of that traffic is routed internally. Internet router hands out DHCP to the WAN side of the 881 router.

Appendix B - Request for Proposal Technical Requirements

Equipment Requirements	
COURTROOM EQUIPMENT	
Vendor to provide at least one set of any proposed solution meeting the 5 acceptance criteria defined in requirements below, of courtroom equipment, and must be provided for the period of the assessment program, including training on use of the equipment.	Mandatory
<u>Criteria 1:</u> Equipment originally designed for video remote, simultaneous interpretation (audio remote only if video remote not available).	Preferred
<u>Criteria 2:</u> Equipment which can be modified or paired with other equipment and work for simultaneous.	Preferred
<u>Criteria 3:</u> High end video conferencing equipment (e.g., Codec C60, EX60s/EX90s etc.). Simultaneous functionality is preferred.	Preferred
<u>Criteria 4:</u> Software endpoint video conferencing (e.g., Cisco Jabber, Skype for Business) which can run on any computer. Simultaneous functionality is preferred.	Preferred
<u>Criteria 5:</u> Fresno-type on premise solution as described in Attachment 11 .	Preferred
INTERPRETER SERVICE PROVIDER EQUIPMENT	
Vendor to provide at least 3 and up to 5 interpreter provider workstation solutions from any of the 5 acceptance criteria described for the courtroom equipment (see above), that will best work with multiple courtroom endpoints. May include more than one type of interpreter workstation solution for better comparative data.	Mandatory

Technical Requirements

Proposed VRI Solution must meet all of the NCSC Minimum Technical Requirements recommended in [Remote Interpreting Guide for Courts and Court Staff](#).

EQUIPMENT

The vendor's VRI solutions shall build on existing infrastructure.	Mandatory
The vendor's VRI solutions shall allow for point to point intra-court, inter-court, and court to independent contractor video remote interpreting.	Mandatory
Equipment must be portable/ mobile and may be moved to different courtrooms for the duration of the assessment.	Mandatory
Equipment must have the ability to provide a separate and secure audio/video channel for confidential attorney-client communications.	Mandatory
Equipment must meet the following technical minimum requirements: Reliability - system to work all of the time and every time Quality - business-quality audio and video to ensure appropriate due process	Mandatory
Equipment should meet the following technical minimum requirements: Interoperability - ability to switch among providers or use multiple providers easily: - Use non-proprietary video and audio technical standards - Use widely available video and audio technical standards	Preferred
Equipment should meet the following technical minimum requirements: Modes of Interpretation: - Provide simultaneous interpretation capability - Provide private sidebar interpretation capability	Preferred
Product offering must provide at least 720p-30FPS grade video, with multi-channel audio.	Mandatory
Audio signals in the 8 to 20khz range shall be reliably reproduced.	Preferred

NETWORK INFRASTRUCTURE

The vendor shall build its VRI solution network infrastructure using the existing LAN/WAN infrastructure.	Mandatory
The vendor to provide network design specifications for its VRI product offering that does not alter the security posture of the court's network.	Mandatory
Design specifications shall include bandwidth specifications that scale for users and include options for different CODECS to reduce network impact.	Mandatory
Vendor to provide sample QoS settings for optimum video and voice quality.	Mandatory

SCALABILITY

System shall provide options to scale vertically or horizontally to allow for increased adoption.	Mandatory
VRI solution shall be scalable to accommodate court size, court users, data volume, and internet users.	Mandatory

SECURITY

VRI solution shall be secure and meet the guidelines set forth in RFP Attachment 15 and the NIST SP 800-53 standards for the back end.	Mandatory
The system must support a secure communication channel to protect communications and document transfers.	Optional

MONITORING

System shall provide diagnostic and monitoring functionality.	Mandatory
---	-----------

Appendix C – Glossary

CALNET 3 – California Network and Telecommunications program offers competitively bid telecommunications contracts to all state and local government agencies. Version 3 provides new services such as Unified Communications.

CCTC – California Courts Technology Center. The Tech Center hosts several applications for the courts, e.g., SAP, facilities management, etc. Participating courts connect to the CCTC via AT&T private MPLS circuits or site-to-site VPN tunnels over the internet.

Codec – Encoder/decoder. Essentially a network-enabled device that simplifies the setup of videoconferencing capabilities for a given environment. Typically bundled with a camera and microphone. Accepts up to two HDTV display inputs.

CoS – Class of Service.

Demonstrate – the vendor successfully demonstrated one or more features of their solution in a mock trial setting.

DMVPN – Dynamic Multipoint VPN. A type of firewall used by Connected Justice.

DSP – Digital Signal Processor.

Endpoint – All videoconferencing devices that plug into the LAN, including cameras, phones, and integrated displays.

HDTV – High Definition Television.

IPsec – Internet Protocol Security.

JCC – Judicial Council of California.

LAN – Local Area Network. A network that connects end users to local IT resources such as Active Directory servers, file/print servers, printers, etc. through network cabling or Wi-Fi access points.

LEP – Limited-English Proficient court user.

MPLS – Multiprotocol Label Switching. A common type of WAN circuit. Also, AT&T's technique of speeding up and shaping traffic flows across enterprise wide area networks.

POV – Proof of Value, a term used by Connected Justice Consortium

QoS – Quality of Service markings are used to prioritize voice and video traffic.

RI – Remote Interpreter. A California court-certified and registered interpreter skilled in two or more languages, including ASL, working from a courtroom facility.

Test – The court IT staff tested one or more features of their solution during implementation, and prior to an actual hearing that employed VRI technology.

UPS – Uninterruptible Power Supply.

VLAN – Virtual LAN. A network configuration that segregates VRI data to desired switches and routers for security.

VPN – Virtual Private Network. In the context of a site-to-site tunnel, this type of encrypted connection is used over a court’s existing public internet connection; may serve as a lower-cost alternative to MPLS.

VRI – Video Remote Interpreting.

WAN – Wide Area Network. A network that connects organizationally related but geographically separated offices, their LANs, and physical or virtual data centers together.

DRAFT

Evaluation of a Video Remote Interpreting Pilot Program in California

FINAL REPORT

DATE: DECEMBER 2018



Provided to:
Judicial Council of California

By:
Sheldon Zhang, PhD



**SAN DIEGO STATE
UNIVERSITY**

Table of Contents

TABLE OF CONTENTS	2
EXECUTIVE SUMMARY	3
CHAPTER 1: KEY TAKEAWAYS FROM THE REVIEW OF THE LITERATURE	4
CHAPTER 2: EVALUATION PLAN	5
Proposed Evaluation Plan.....	5
Key Evaluation Questions.....	6
Data Sources	7
Proposed Data Collection Plan.....	8
Event Surveys.....	9
CHAPTER 3: FINDINGS.....	19
Findings of Main Research Questions	19
On-Site Observations of Interpreted Events	27
Online Stakeholder Survey	36

Appendix A: Literature Review

Appendix B: Evaluation Plan

Appendix C: Technical Setup of the Pilot and Assistance to the Courts

Appendix D: Data Collection Instruments

Appendix E: Evaluation Sub-questions

Appendix F: Bibliography

Executive Summary

The overall findings of this study reflect positively the efficacy of Video Remote Interpreting (VRI) as a solution to the needs of Limited English Proficient (LEP) population in the courts evaluated in this study.

- In 95% of the court proceedings surveyed, judges determined that VRI allowed for effective communication between the LEP court users and the courtroom.
- 59% of post-pilot survey respondents felt that VRI allowed the LEP court users to meaningfully participate in court proceedings.
- In 61% of all court events, both judicial officers and interpreters considered VRI as effective as in-person interpretation. In all, 95% of the responses considered VRI either “very effective” or “somewhat effective.”
- In the post-pilot online survey, all judges, interpreter coordinators, IT staff, and other court staff either strongly agreed or agreed that VRI provided effective interpreting. However, more than half of the interpreters either disagreed (44%) or strongly disagreed (14%) that VRI provided effective interpreting.
- 78% of the LEP court users surveyed immediately after the VRI events were very satisfied with the interpreting they received. Additionally, 96% of LEP court users who were provided with VRI interpreting found the equipment easy to use.
- No difference was found in LEP court users’ satisfaction with VRI interpreted events based on vendor or language of interpreting.
- Perceived effectiveness of VRI varied significantly across types of court cases. VRI was perceived as very effective in 79% of events for felonies, 65% for infraction events, 63% for traffic events, and 40% for misdemeanor events.
- Events using Paras & Associates VRI technology were perceived slightly more effective than those using technology provided by Connected Justice. This slight advantage in favor of Paras & Associates was again observed in the post-pilot survey data.
- 88% of post-pilot survey respondents felt that there was no significant difference in effectiveness between VRI events interpreted by an interpreter in the same county and those interpreted by an interpreter located in a different county.
- VRI equipment functioned exceedingly well in this pilot study, with nearly all participants (about 94%) in all events indicating they could see and hear all other court participants clearly, and felt the audio and video feeds were synchronized. No significant difference was found between the two vendors on this issue.
- Court staff reported no technical problems with the VRI equipment that delayed the start of the court proceeding more than 10 minutes; and in only 10 events (3%) an equipment problem delayed an event more than two minutes once it was already started. No difference across vendors was found for technical problems.

Chapter 1: Key Takeaways from the Review of the Literature

A detailed review of research literature on VRI is included in Appendix A. A summary of the key takeaways is presented here. Overall the research literature suggests that VRI may improve language access to LEP court users, may enable the increased use of certified or registered interpreters, may reduce delays or reschedulings of LEP court user events, and may result in savings for the court. However, in many courts, it is a new or untested procedure, and as such will involve substantial changes in procedures which necessitate careful forethought, planning, training, and documentation.

- **Research on previous VRI use and lessons learned in prior court implementations should be studied and incorporated into any VRI implementation.**
The literature reviewed in this report provides a wealth of information and recommendations. In order to succeed, any future implementations should capitalize on lessons learned from previous implementations.
- **Consistently implement a rigorous and clear set of guidelines regarding assignment of appropriate cases to VRI.**
All parties should be empowered to assess the attributes of events appropriate for VRI.
- **All involved parties (judges, attorneys, interpreters, and court staff) should receive comprehensive training in VRI procedures.**
Training should address ethical, technical, administrative, and procedural issues, should be ongoing, and should include support materials available either in print or on a website.
- **Printed event checklists, benchcards, or other procedural materials should be developed and consistently implemented.**
In order to ensure that best practice guidelines are being followed, judges and court staff should be provided with printed documentation which reviews guidelines for appropriate assignment of cases to VRI and for all event tasks. This document should include a description of VRI which can be relayed to event participants, informed consent procedures for the LEP person, and information for involved parties regarding how to pause proceedings to notify a problem or request clarification, and any needed scripts the judge must read.
- **Interpreters assigned to VRI should be provided with sufficient training, support, advance notice, and any necessary documentation prior to an event.**
Research indicates that additional training results in greater interpreter comfort and satisfaction with VRI.

Chapter 2: Evaluation Plan

Our evaluation plan assumes the in-person interpretation to be the gold standard against which VRI is compared, although, to our knowledge, there is no literature that attests whether it is, in fact, providing effective communication and/or due process to LEP court users. The literature on assessment of interpreting reflects ongoing debate regarding the definition of quality and which party (the interpreter, the recipient, or an external observer) should assess quality. This study assumes that all certified/registered interpreters are qualified to provide equally effective interpreting services and therefore any differences detected between the two interpreting modalities are primarily structural or technical. A more detailed discussion of the research plan in this study is included in Appendix B.

PROPOSED EVALUATION PLAN

Multiple iterations of the evaluation plan were submitted to the Judicial Council of California (JCC) between September 2016 and June 2017. All of these plans were directly informed by a close examination of documents provided by the JCC, including the *Outline of Evaluation Services for the VRI Pilot Program*, and the *Backgrounder on VRI Pilot*, and specifically addressed the primary research questions included in those documents.

The initial evaluation plan recommended by San Diego State University (SDSU) was based on a randomized control trial (RCT) design in which, for a period of time (e.g., four weeks), all cases eligible for VRI would be randomly assigned to either VRI or in-person interpretation. The plan also included surveying LEP court users, and having court staff complete brief surveys after every interpreted event. This plan was presented to the JCC team on February 10, 2017.

This design required that VRI eligibility criteria follow the same elements already established by an agreement between the JCC and CFI, such as for events of short duration, non-evidentiary hearings, and non-complex cases. Data would then be analyzed to assess whether or not there was a statistically significant difference in the perceived effectiveness of communication provided by the two methods.

The JCC was also interested in assessing whether or not quality or effectiveness of VRI varied significantly across multiple other variables, including:

- Case type
- Event type
- Vendors
- Technology used
- Language

However, the JCC did not feel that an RCT design would be possible in the pilot. Instead, VRI cases were assigned to specific time periods (certain weeks or days), and in-person interpreting was conducted during other time periods. Each court implemented VRI to best suit its scheduling and structural needs.

Although data was collected on some of these variables, SDSU researchers conveyed to the JCC that without random assignment of each variable, it would not be possible to determine with absolute certainty whether any differences between outcomes was a direct result of the variable of interest.

KEY EVALUATION QUESTIONS¹

All of the evaluation questions were generated, reviewed, and edited based on (1) VRI best practices gleaned during the literature review, (2) the submission and revision of several previous evaluation plans, and (3) a series of conversations and meetings with key JCC and court staff and the judges involved in the VRI pilot project. In conjunction with the JCC, it was determined that this study would attempt to examine whether or not VRI can provide effective communication and due process to LEP court users in specific types of court events when qualified in-person interpretation is not available; and whether implementation of VRI improves access to language services to LEP court users (defined as expediency or shortened delays in obtaining interpretation services from certified/registered interpreters and/or improved access to certified/registered interpreters).

The primary evaluation questions were:

1. Do intercept surveys of judges, LEP court users, court staff, and interpreters indicate a significant difference in perceived effectiveness between the two interpreting modalities?
2. Does an analysis of observation data of VRI and in-person interpretation of court events indicate a significant difference between the two modalities as far as length of event (for traffic cases only), number of times interpreters requested information to be repeated or number of times interpreters requested that any event participant slow down?
3. Do stakeholders believe the VRI solutions implemented during the pilot provided effective communication and interpretation for LEP court users?
4. Did the implementation of VRI during the pilot increase the use of certified/registered interpreters?
5. Did the implementation of VRI at the three pilot sites reduce the amount of delays and or rescheduling for LEP court user events?
6. Did the implementation of VRI during the pilot period result in any cost savings for participating courts?
7. Did the quality or effectiveness of VRI vary significantly across sites, vendors, event length, or language?

For evaluation sub-questions, refer to Appendix E.

¹ The final evaluation questions and evaluation plan were submitted to the JCC as Task 2 and Task 3 Deliverables on July 18, 2017 and July 25, 2017, respectively.

DATA SOURCES

In order to answer these questions, the evaluation plan included the following data collection activities:

1. Brief event surveys to be completed by judicial officers, interpreters, LEP court users, and court staff immediately after each interpreted event during the pilot. ²
2. On-site observations of VRI and in-person events by SDSU researchers, using an observation rubric.
3. A post-pilot online survey of key stakeholders, including judicial officers, attorneys, interpreters, and court staff who participated in the pilot.
4. A review of scheduling data (to be collected and provided by participating courts).

All data collection instruments were reviewed and edited based on feedback provided by the JCC.

Table 1 below outlines the key evaluation questions as well as data sources for each question.

Table 1. Key evaluation questions and data sources

KEY EVALUATION QUESTIONS	DATA SOURCES
A. Do intercept surveys of judges, LEP court users, court staff, and interpreters indicate a significant difference in perceived effectiveness between the two interpreting modalities?	Intercept surveys of judges, LEP court users, interpreters, courtroom staff, court interpreter coordinators, and IT staff conducted at each event (both modalities)
B. Does an analysis of observation data of VRI and in-person interpretation of court events indicate a significant difference between the two modalities as far as length of event, number of times interpreters requested information to be repeated or number of times interpreters requested that any event participant slow down?	On-site observations of both VRI and in-person interpreted courtroom events

² The evaluation plan approved for implementation included event survey data collection during events occurring in six different courtrooms, each with different event types, three of which were provided equipment by one vendor (Paras & Associates) and three of which were provided equipment by a second vendor (Connected Justice). Events were not randomly assigned to VRI or in-person, were not randomly assigned to a specific court, and were not randomly assigned to a specific vendor.

KEY EVALUATION QUESTIONS	DATA SOURCES
C. Do stakeholders believe the VRI solutions implemented during the pilot provided effective communication and representation of LEP court users?	Online surveys to be sent via email towards end of implementation period to key stakeholders including judges, attorneys, interpreters, interpreter coordinators, court IT staff, courtroom staff, and other court staff
D. Did the implementation of VRI during the pilot increase the use of certified/registered interpreters?	Analysis of administrative, scheduling and pay data provided by courts to assess pre-and post- differences in usage patterns; online survey data
E. Did the implementation of VRI at the three pilot sites reduce the amount of delays and or rescheduling for LEP court user events?	Analysis of administrative, scheduling and pay data provided by courts to assess pre-and post- differences in usage patterns; online survey data
F. Did the implementation of VRI during the pilot period result in any cost savings for participating courts?	Analysis of administrative, scheduling and pay data provided by courts to assess pre-and post- differences in usage patterns. To be collected towards end of VRI implementation across all court sites; online survey data

PROPOSED DATA COLLECTION PLAN

This section outlines the data collection and analysis plan that was proposed to the JCC initially. The JCC and courts requested multiple changes, which are described subsequently in the report.

Site Visits

SDSU researchers planned to conduct an initial site visit to each pilot court in order to document specifics of VRI setup at each site. SDSU also planned to use these initial visits were to be used to conduct training for court staff in the administration of the online intercept surveys and data entry of paper surveys.

Event Surveys

SDSU proposed conducting event-specific intercept surveys of judges, LEP court users, court interpreters, courtroom staff, court interpreter coordinators, and court IT staff immediately after both VRI and in-person interpreted events during the pilot. SDSU researchers initially proposed administering the event surveys using tablets purchased by the JCC. SDSU researchers planned to monitor the data being collected throughout the pilot to get a sense of the number of events that data would be captured for, and to alert the JCC staff of any issues or problems with VRI equipment that may need troubleshooting.

On-Site Observations

SDSU researchers proposed conducting 10 days of on-site observations in two Sacramento courts, once the VRI equipment was installed and was working to the satisfaction of each court. SDSU planned to attend and observe both VRI and in-person interpreted events and collect data using an observation rubric.

Post-pilot Stakeholder Surveys

The data collection plan included an online survey to be sent by SDSU via email after the VRI pilot assessment period to key pilot stakeholders who participated in the pilot, including judges, attorneys, court interpreters, courtroom staff, court interpreter coordinators, involved court IT staff, and any other court staff.

Court-Provided Scheduling Data

The original data collection plan requested scheduling and cost data from the JCC. SDSU requested information about the number of events that were rescheduled or delayed due to the lack of availability of a registered/certified interpreter for a specified period of time during the pilot, for the in-person and the VRI courtrooms.

EVENT SURVEYS

Brief surveys were completed by judicial officers, LEP court users, court interpreters, courtroom staff, court interpreter coordinators, and court IT staff immediately after both in-person and interpreted events during the six-month pilot period. The purpose of these surveys was to obtain feedback from court event participants about their experiences and perceptions of the interpreting provided (either in-person or via VRI) during each event.

Methods

SURVEY INSTRUMENT

The event survey instrument was designed based on key evaluation questions and best practice recommendations (outlined in Chapter 1). SDSU drafted event survey questions, which were reviewed by the JCC, the VRI Pilot Project Workstream, and the pilot courts. After conducting the initial site visits, further changes were made to the survey questions based on the processes observed during training. Individualized survey versions were designed for each respondent group at each courtroom.

The LEP court user version of the survey included a question obtaining informed consent, which provided a brief description of the purpose of the survey and the evaluation as well as an option to opt out of the survey. Spanish, Punjabi, Russian, Chinese, and Vietnamese translations of the LEP court user survey were provided by the JCC. SDSU researchers formatted and individualized the five translated versions of the LEP court user survey for each court as well (see Appendix D for samples of the paper survey).

Prior the VRI pilot, all survey versions were combined into a master survey and programmed for online administration and data entry using the Qualtrics Survey Software package. Programming included locations for responses, checks for acceptable responses, respondent instructions, and

necessary skip patterns. Programming and data conversion were tested prior to survey implementation.

DATA COLLECTION

Although data collection was originally planned to be conducted electronically using tablets provided by the JCC, most of the data collection was conducted using paper versions of the survey. SDSU researchers provided paper versions of the survey for each court. Individualized paper versions of the event surveys were provided to each court as needed. The link to the online survey and paper versions of the survey were provided to the courts on November 29, 2017, along with recommended planning guidelines for survey implementation.

Table 2. Format of surveys at six pilot courtrooms

SURVEY FORMAT	SAC: Mail Jail (Dept. 63)	SAC: CMJC (Dept. 81)	Merced (Court-room 9)	Los Banos (Court-room 13)	Ventura (Court-room 10)	Oxnard (Court-room J5)
Judicial Officer	Paper	Paper	Online	Online	Paper	Paper
Interpreter	Paper	Paper	Online	Paper	Paper	Paper
Court Staff	Paper	Paper	Paper	Paper	Paper	Paper
LEP court user	Paper	Paper	Both	Paper	Paper	Paper

In-person training on survey administration and data entry was provided to the Sacramento and Merced court staff. In-person survey administration and data entry training was offered by SDSU to Ventura, but was deemed not necessary by the Ventura project manager. Training materials were provided to all sites. An overview of training conducted and copies of training documents provided was provided to the JCC as part of Task 5 Deliverable. Data collection was conducted by court staff in each court from February 1, 2018 to August 31, 2018. Courts were provided with a link to an online report that tracked the number of surveys completed at each site. At courts using paper survey, court staff entered data from completed paper surveys into a link to the electronic version. The survey was closed on August 31, 2018, and data was exported from Qualtrics into SPSS. All data analysis was conducted in SPSS. The codebook and frequency distributions for the event survey data were provided to the JCC as part of Task 9 Deliverable on September 8, 2018.

POTENTIAL LIMITATIONS

1. **Missing data:** The court event survey was designed to collect data for every interpreted court event (either in-person or VRI) during the pilot period. In theory, this would result in the same number of surveys completed by judicial officers, LEP court users, and interpreters for each site; however, this was not the case. It is possible that certain court participants were unable to fill out surveys for each event they attended. Final data represents only events for which surveys were completed.

2. **Satisficing:** LEP court users were administered surveys by the same interpreters who provided them with interpreting services. In situations such as this, there is a risk of satisficing—the respondent providing answers that they feel will be better received by the interviewer.
3. **Data Entry:** There was a risk of data entry errors for courts that opted to use paper surveys. To mitigate data entry risk, SDSU researchers collected the entered paper surveys at the end of the pilot period and verified if data entry was conducted correctly, by checking 10% of surveys from each site.
4. **Recall Bias:** It is possible that court participants did not complete surveys immediately after court events, but at a later time, increasing the risk of misremembering or forgetting data points.

Results

A total of 3,856 surveys were entered by court staff. After removing incomplete and duplicate surveys, a total of 3,737 surveys remained. Of these, 2,265 (61%) were completed for in-person interpreter events, and 1,472 (39%) were completed for VRI events. **Tables 5, 6, and 7** show the distribution of complete, non-duplicated surveys for each court.

Table 3. Event surveys completed at Sacramento

Surveys Completed	Sacramento: Main Jail Courthouse (Dept. 63)			Sacramento: Carol Miller Justice Center (Dept. 81)		
	In-person	VRI	Total	In-person	VRI	Total
Judicial Officer	93	39	132	192	93	285
Interpreter	18	35	53	25	121	146
LEP Court User	10	18	28	19	104	123
Interpreter Coordinator	0	3	3	0	0	0
Court Staff	84	30	114	59	50	109
IT Staff	0	0	0	0	0	0
TOTAL	205	125	330	295	368	663

Table 4. Event surveys completed at Merced

Surveys completed	Merced (Courtroom 9)			Los Banos (Courtroom 13)		
	In-person	VRI	Total	In-person	VRI	Total
Judicial Officer	112	78	190	6	23	29
Interpreter	111	85	196	43	51	94
LEP Court User	59	70	129	3	30	33
Interpreter Coordinator	1	1	2	0	0	0
Court Staff	109	83	192	91	38	129
IT Staff	0	0	0	0	0	0
TOTAL	392	317	709	143	142	285

Table 5. Event surveys completed at Ventura

Surveys Completed	Ventura (Courtroom 10)			Oxnard (Courtroom J5)		
	In-person	VRI	Total	In-person	VRI	Total
Judicial Officer	13	93	106	15	27	42
Interpreter	379	93	472	10	40	50
LEP Court User	396	80	476	14	40	54
Interpreter Coordinator	2	1	3	0	0	0
Court Staff	379	118	497	22	25	47
IT Staff	0	0	0	0	3	3
TOTAL	1,169	385	1,554	61	135	196

CASE TYPES AND CASE EVENTS

Case Types

All respondent groups except LEP court users were asked to indicate the case type for each event survey. Of the 2,878 event surveys completed by judicial officers, interpreters, interpreter coordinators, and court staff, 1,024 were from traffic events, 815 were from infraction events, 754 were from misdemeanor events, 277 were from felony events, one was from drug court, two were from a civil event, and five were from small claims.

Table 6. Event survey: Case types

Case type	In-person	VRI	Total
Civil (other)	2	0	2
Drug court	1	0	1
Felony	174	103	277
Infraction	475	340	815
Misdemeanor	533	221	754
Small claims	5	0	5
Traffic	562	462	1,024
TOTAL	1,752	1,126	2,878

Table 7. Event survey: Case events [can be multiple cases for each event]

Case Event	In-person	VRI	Total
Admit/deny violation of probation	3	2	5
Arraignment	1,388	858	2,246
Bail review	14	10	24
Case management conference	3	3	6
Conference	4	13	17
Court trial	27	4	31
Demurrer	0	0	0
Further proceedings	13	25	38
Motion	0	0	0
Order to show cause	0	0	0
Parole/Post-release community supervision hearings	0	0	0
Petition	1	1	2
Plea	36	39	75
Preliminary hearing	0	0	0
Pre-prelim	0	0	0
Pre-trial	7	1	8
Progress report	5	4	9
Proof	2	8	10
Restraining order hearing	0	0	0
Review hearing	26	16	42
Sentencing	104	75	179
Settlement conference	86	44	130
Transfer	0	0	0
Trial	24	30	54
Trial readiness	11	1	12
Violation of probation	3	6	9
Violation of probation/arraignment	10	4	14
Violation of probation/arraignment/sentencing	4	5	9
Walk-in	7	6	13
Other	153	97	250

Interpreter Type

Of the event surveys completed by interpreters for in-person events, 98% of the in-person surveys were completed by a certified interpreter and 2% were completed by a registered interpreter. Of those completed for VRI events, 99% were completed by a certified interpreter and 1% were completed by a registered interpreter. There was no significant difference between the proportion of certified and registered interpreters across the two modes of interpreting.

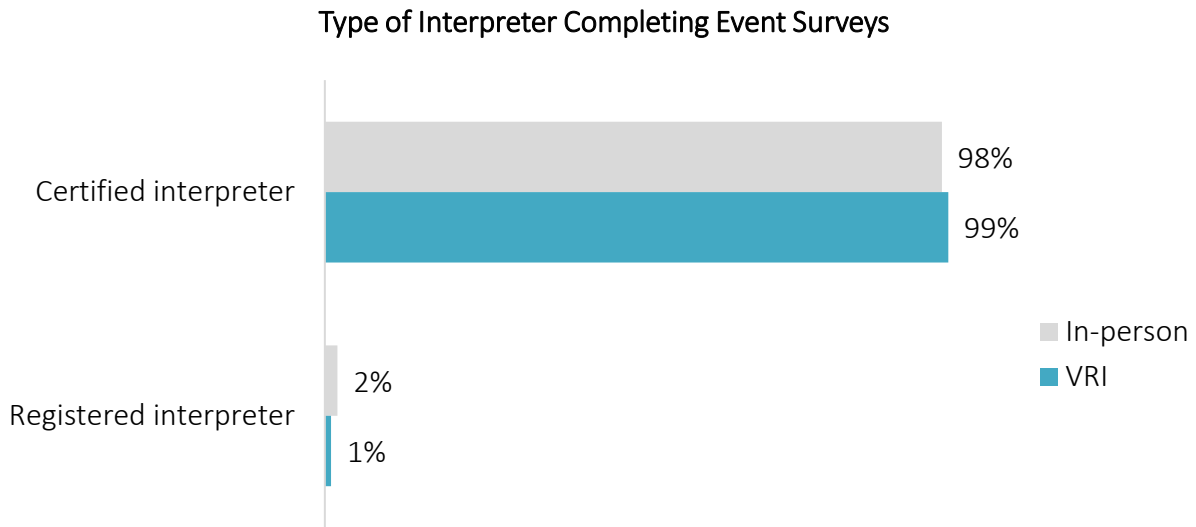

Language

Of the event surveys completed for in-person events, 88% were from events interpreted in Spanish and 12% were from events interpreted in a language other than Spanish. There was no difference in LEP court user satisfaction levels between VRI interpreted events interpreted in Spanish and those interpreted in languages other than Spanish.

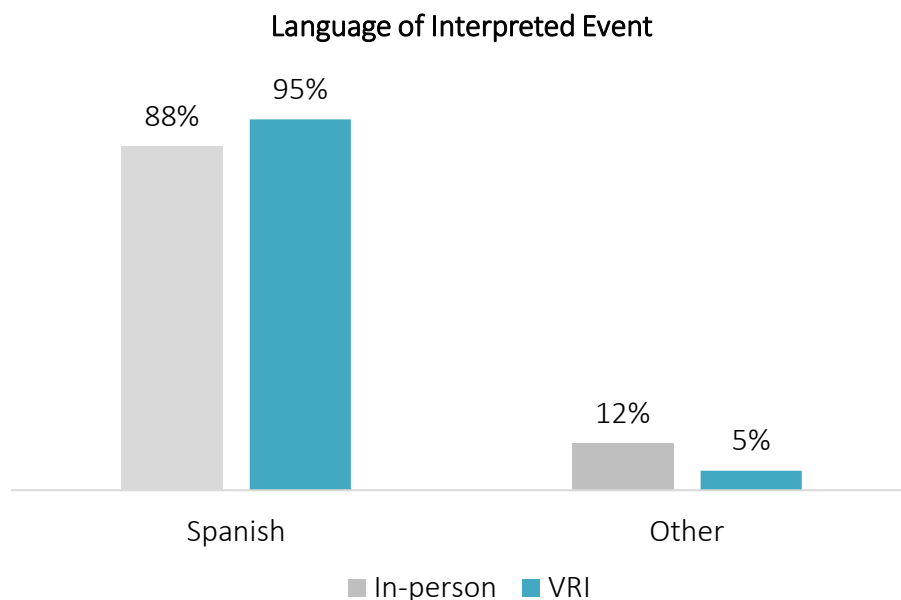
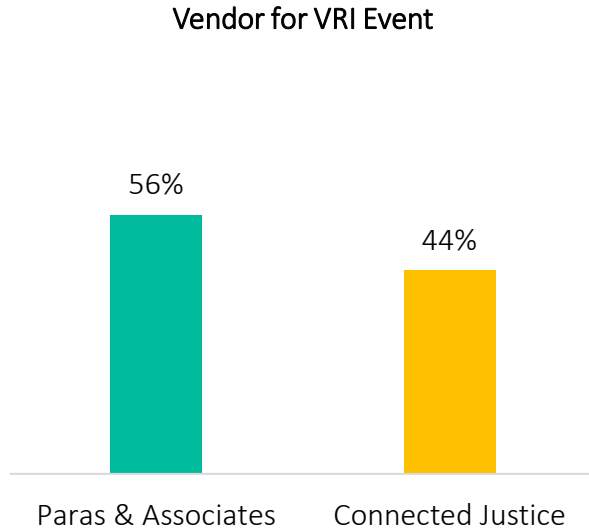

Table 8. Other languages of interpreted events

Case Event	In-person	VRI	Total
Arabic	10	0	10
Armenian	9	0	9
ASL	5	12	17
Bengali	3	0	3
Cantonese	18	0	18
Chinese [NOT SPECIFIED]	5	0	5
Dari	6	0	6
Ethiopian	1	0	1
Farsi	7	0	7
Hindi	3	0	3
Hmong	9	0	9
Laotian	1	0	1
Mandarin	47	2	49
Mien	4	0	4
Mixteco	2	0	2
Mixteco and Spanish	1	0	1
Punjabi	11	0	11
Romanian and Russian	1	0	1
Russian	56	37	93
Samoan	3	0	3
Urdu	1	0	1
Vietnamese	12	3	15
TOTAL	215	54	269

Vendor for VRI Events

Of all the event surveys, 56% were completed for events which used VRI solutions provided by Paras & Associates, and 44% were for events which used VRI solutions provided by Connected Justice.



Duration of VRI Event

The JCC recommends that events that use VRI should be less than 30 minutes in length (Judicial Council of California, 2012). Interpreters and court staff were asked about the duration of the proceeding regardless of whether it conducted by an in-person interpreter or was via VRI.

Judicial officers were asked about the duration of VRI court events only. The vast majority (92%) of VRI events were less than 15 minutes in length.

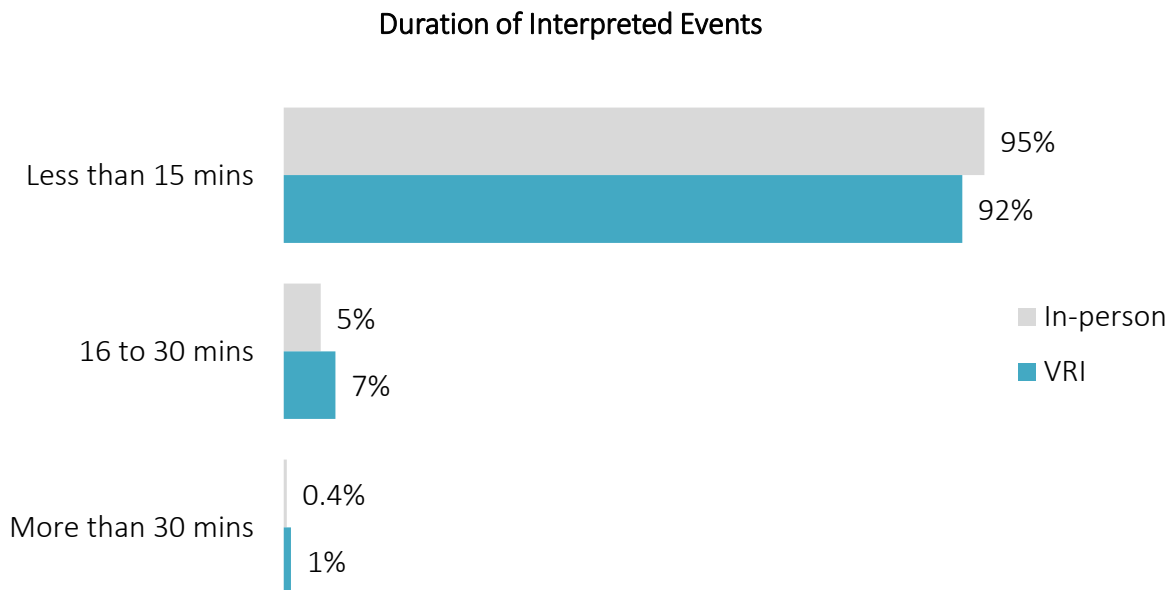

Types of Interpreting Provided During VRI Events

Event surveys completed by interpreters indicated that consecutive interpreting was provided in 89% of VRI events, simultaneous interpreting was provided in 53% of VRI events, sight translation was provided in no VRI events, and interpreting for confidential conferencing between the LEP court user and his or her attorney was provided in 5% of VRI events.

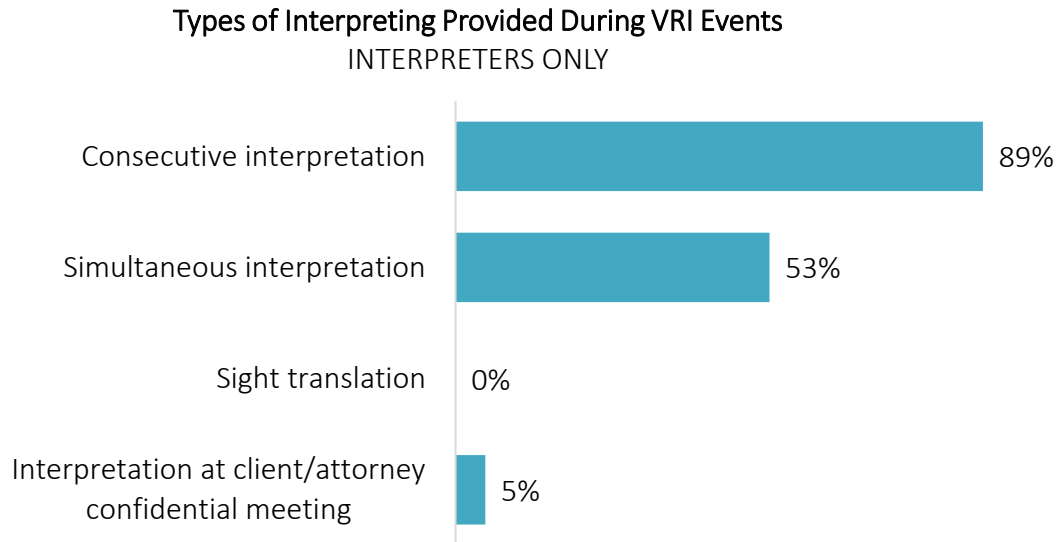

Chapter 3: Findings³

The following charts presents the key findings to the primary evaluation questions agreed upon by the Judicial Council of California (JCC) and San Diego State University (SDSU). Percentages depicted in charts and tables in this report may not add up to 100% because of rounding.

FINDINGS OF MAIN RESEARCH QUESTIONS

Perceived Effectiveness of VRI

Judicial officers were asked (1) whether or not the VRI event needed to be stopped as a result of an objection to the use of VRI, (2) whether they felt the VRI event allowed for effective communication between the LEP court user and the courtroom, and (3) to rate the effectiveness of the interpretation provided during the court proceeding.

Surveys completed by judicial officers indicated that the VRI event needed to be stopped as a result of an objection to the use of VRI in 11% of events.

**VRI Event Needed to Be Stopped as a Result of Objection
to the use of VRI**
JUDICIAL OFFICERS ONLY

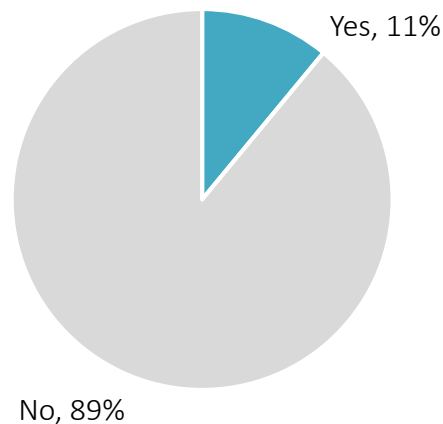

³ A report outlining the evaluation data collection tools was submitted to the JCC as Task 4 Deliverable on September 18, 2017. An overview of trainings conducted, including trainings conducted by SDSU researchers was provided to the JCC as Task 5 Deliverable on March 28, 2018. A mid-project report with findings from data collected halfway through the pilot period and recommendations for course corrections was provided to the JCC as Task 7 and Task 8 Deliverables on June 18, 2018.

Ninety-five percent (95%) of judicial officer surveys indicated that the VRI event allowed for effective communication between the LEP court user and the courtroom.

Did the VRI event allow for effective communication between the LEP court user and the courtroom?
JUDICIAL OFFICERS ONLY

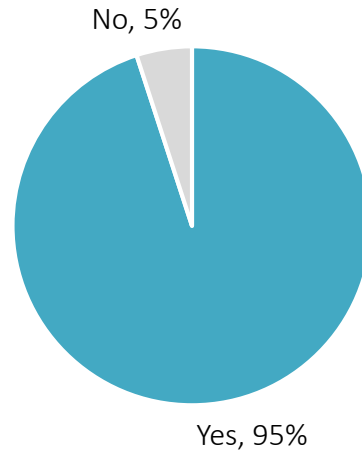

Judicial Officers and Interpreter Perception of VRI Effectiveness

Both judicial officers and interpreters were asked to rate the effectiveness of the interpretation provided during both in-person and VRI events. Although the majority of surveys indicated that interpreting provided by VRI was very effective, there was a statistically significant difference in perceived effectiveness between VRI and in-person events ($p < .05$).

Judicial Officer and Interpreters' Perceived Effectiveness of In-person vs. VRI Interpreting

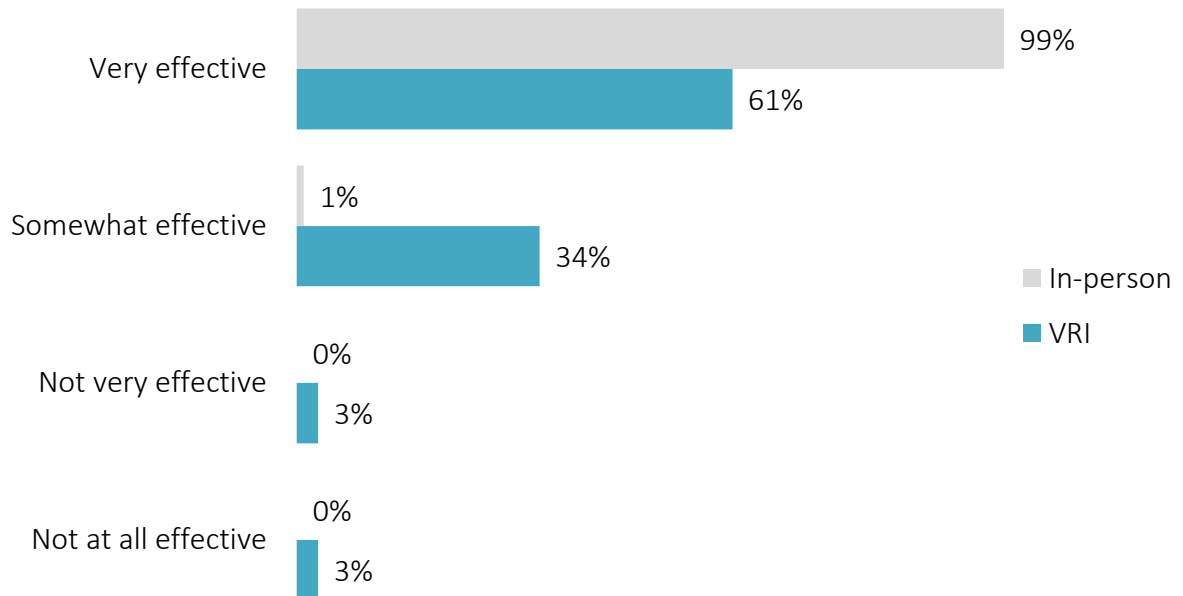

Judicial officers perceived VRI to be significantly more effective than did interpreters ($p < .05$).

Perceived Effectiveness of VRI by Role

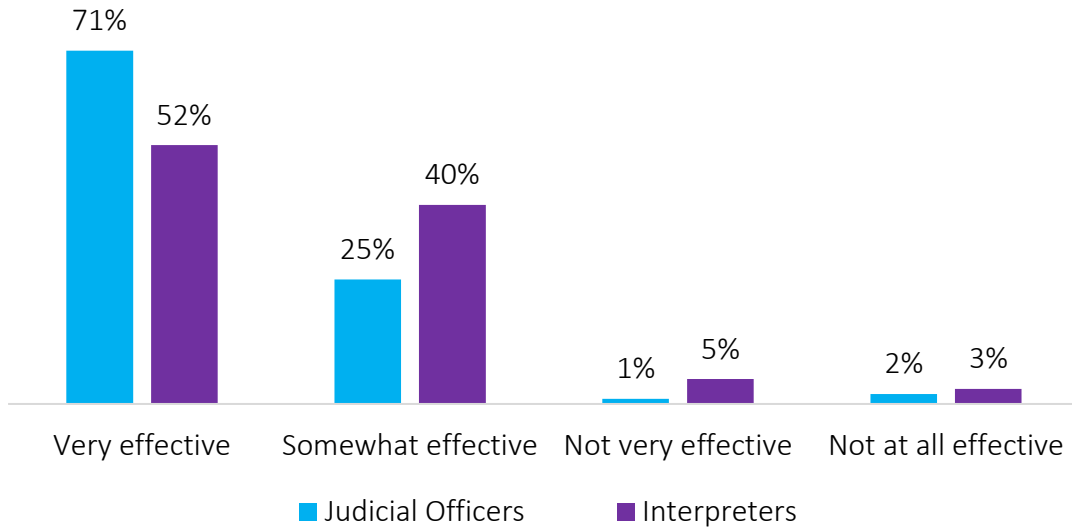

Perceived effectiveness of VRI also varied significantly across case type ($p < .05$).

Perceived Effectiveness of Interpretation Mode by Case Type

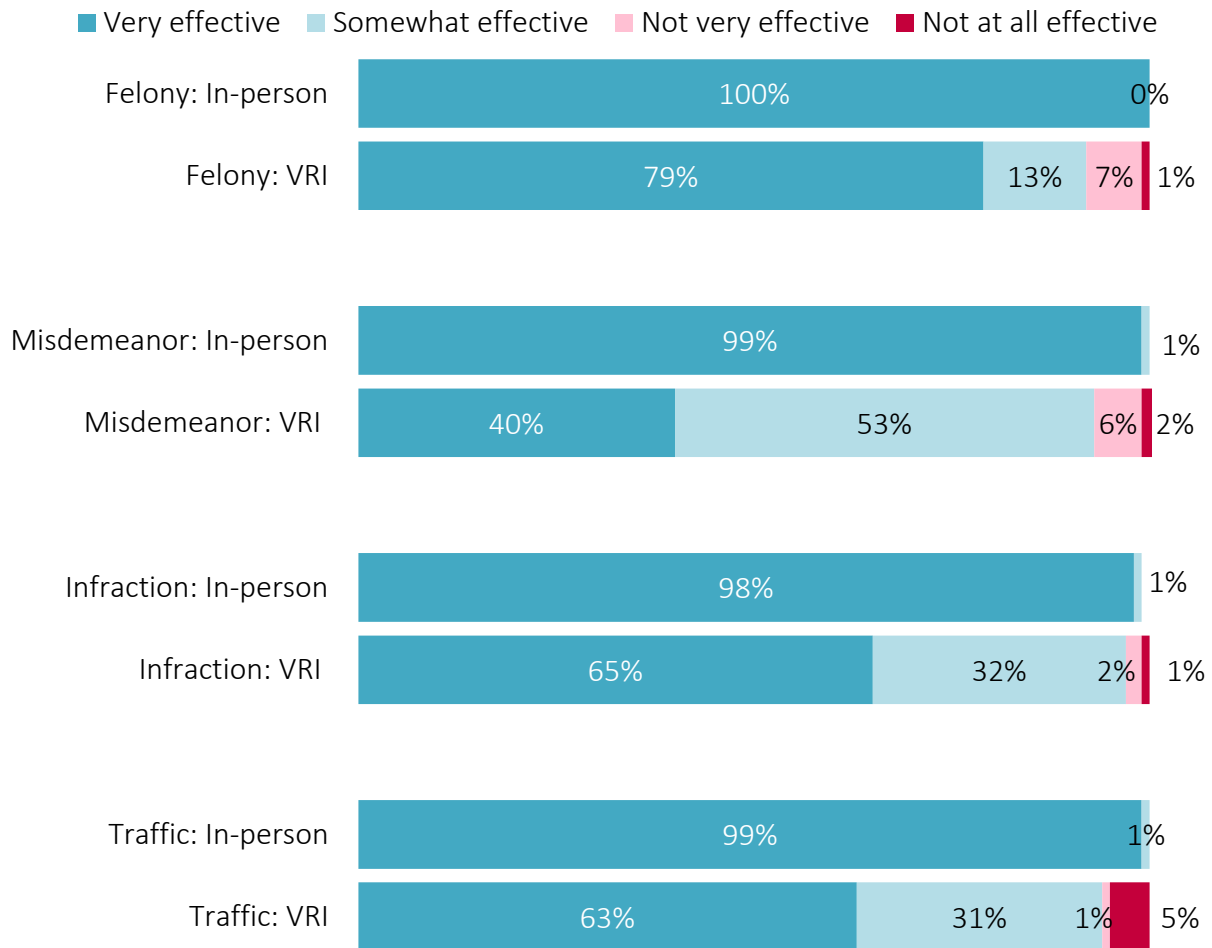

There was no difference in effectiveness found for events of 15 minutes or less and events longer than 15 minutes, and no difference in effectiveness found across events which did or did not include consecutive interpreting, simultaneous interpreting, sight translation, or confidential conferencing between attorney and LEP court user.

LEP Court User Satisfaction with VRI

Over three-quarters of the LEP court users who were surveyed immediately after receiving VRI interpreting were very satisfied with the interpreting they received. Additionally, 96% of LEP court users who were provided with VRI interpreting found the equipment easy to use. However, there was a statistically significant difference in LEP court user satisfaction between the two interpreting modalities ($p < .05$).

LEP Court User Satisfaction with In-Person and VRI Interpreting

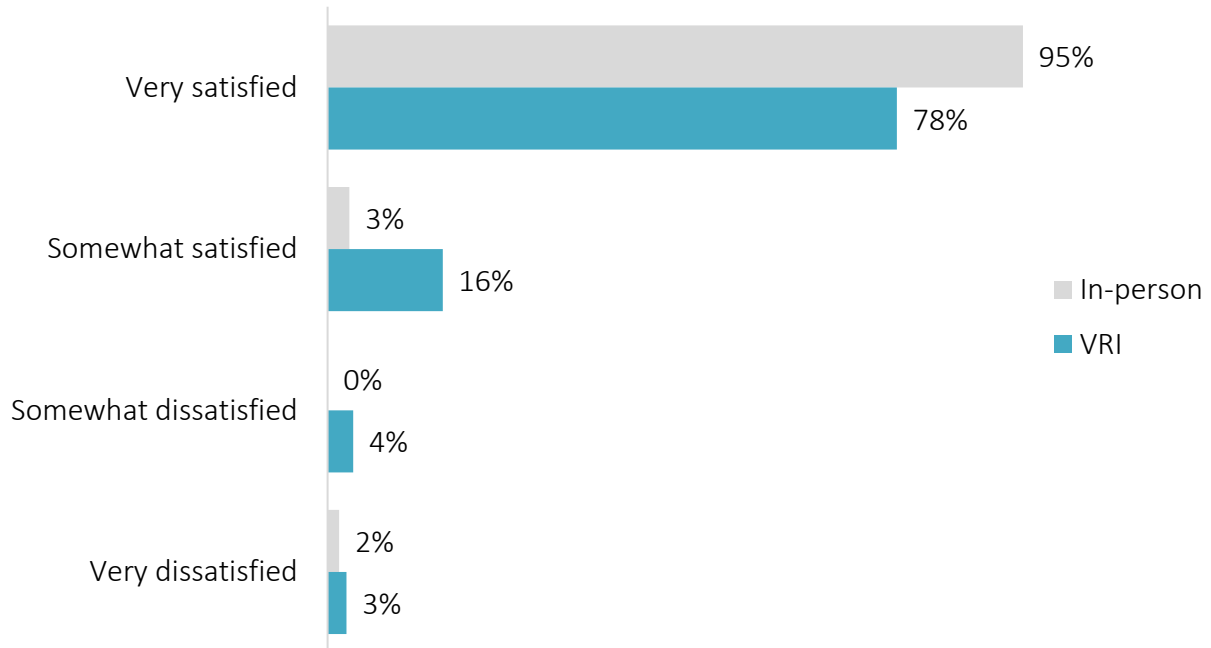

LEP court user satisfaction did not vary significantly across vendors, or across different languages.

VRI Technology during Pilot Events

In 90% of the event surveys, respondents indicated that they could hear all court participants during VRI events. However, the ability to hear all court participants was significantly higher for in-person events than for VRI events ($p < .05$). For VRI events only, there was no significant difference found between vendors in reported ability to hear all court participants clearly.

Able to Hear All Court Participants Clearly,
by Mode of Interpreting

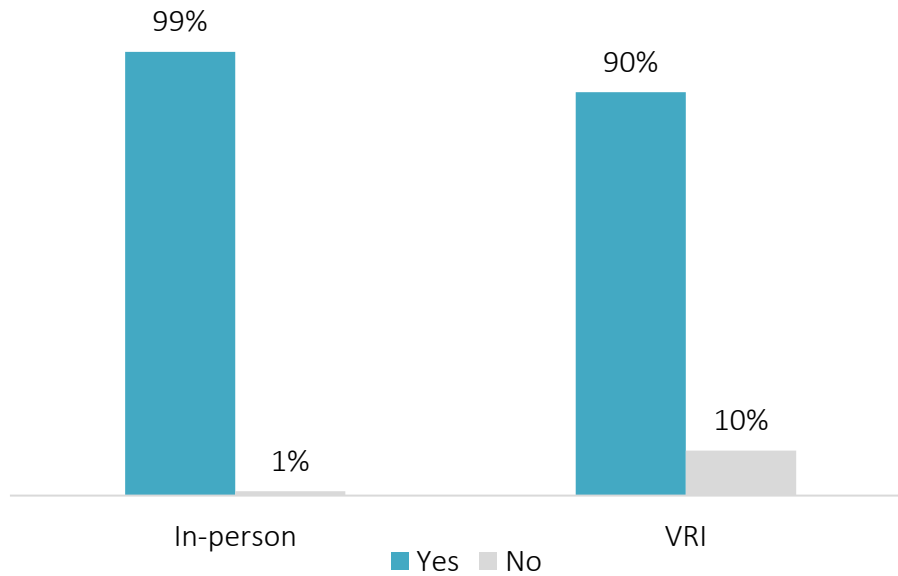

Ninety-four percent (94%) of the event surveys indicated that respondents could see all court participants during VRI events. However, the ability to see all court participants was significantly higher for in-person events than for VRI events ($p < .05$). For VRI events only, there was no significant difference found between vendors in reported ability to see all court participants clearly.

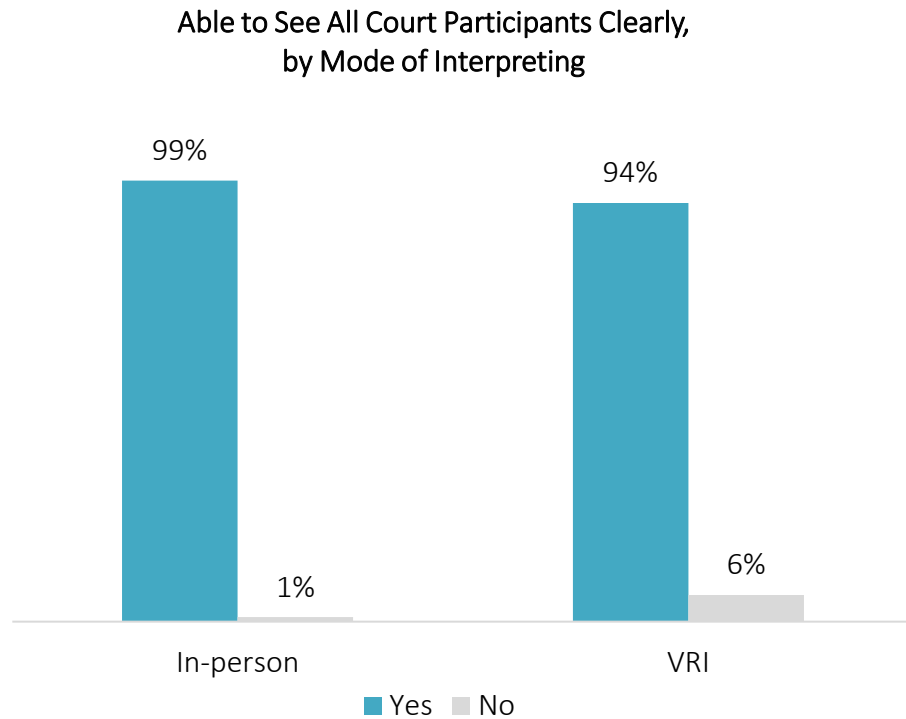

The vast majority of surveys (94%) indicated that audio and video were synchronized during VRI events. There was no significant difference between vendors with regard to synchronization of audio and video feeds.

**Audio and Video Feeds Synchronized
During VRI Events**

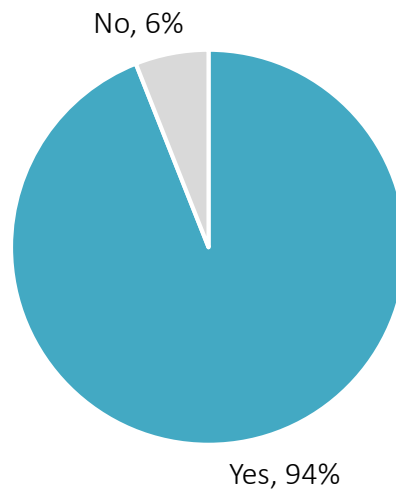

Court staff indicated in 99% of event surveys that there were no technical problems with the VRI equipment which delayed the start of the court proceeding more than 10 minutes and only 10 events (3%), where a technical problem with the equipment delayed an event more than two minutes once it was already started. Two surveys (1%) indicated an event that needed to be rescheduled due to a technical problem with the VRI equipment. There were no statistically significant differences across vendors for technical problems causing delays or rescheduling of events.

Was there a technical problem with the VRI equipment that...

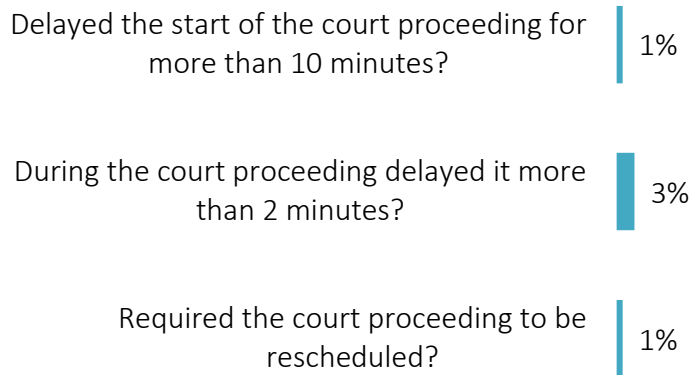

ON-SITE OBSERVATIONS OF INTERPRETED EVENTS

SDSU researchers conducted observations at two Sacramento courtrooms (Departments 63 and 81) for 10 days. SDSU researchers observed both VRI and in-person interpreted events and collected data using an observation rubric. The observation rubric was in the format of a checklist that allowed SDSU researchers to collect data for individual events and items on the checklist were drawn from the literature about VRI best practices, and was reviewed by the JCC before use. Due to equipment setup delays and lack of VRI events, SDSU researchers were able to observe only nine VRI events.

Methods

SDSU researchers designed an observation rubric to document field observations in two Sacramento courts, Sacramento County Main Jail Courthouse (Dept. 63) and Carol Miller Justice Center (Dept. 81). The rubric was designed based on the review of recommended best practices in VRI and was intended to capture quantifiable elements of court events that would (1) document use of recommended best practices and (2) allow for quantifiable comparison of VRI and in-person interpreted events. A copy of the observation rubric is available in Appendix D.

PILOT TESTING OF OBSERVATION RUBRIC

On December 12, 2017, SDSU researchers pilot-tested the rubric at the East County Regional Center of the Superior Court of San Diego. SDSU researchers observed and completed the rubric at multiple court events related to (1) traffic cases, (2) misdemeanor cases, and (3) felony cases. Based on these pilot tests, several changes were made to the observation rubric and a revised version was submitted to and approved by the JCC.

Data Collection

Based on the calendar provided by the JCC and court staff indicating scheduled VRI dates and “control” (in-person) dates, SDSU researchers conducted 10 days of on-site observations in Sacramento at the Sacramento County Main Jail (Dept. 63, with Paras & Associated equipment) and at CMJC (Dept. 81, with Connected Justice equipment). Despite visiting both courtrooms during two weeks indicated to be “VRI” weeks, SDSU researchers were able to observe only nine VRI events.

Table 9. Interpreted events observed at Sacramento courts, March – May 2018

	Sacramento County Main Jail (Dept. 63)		Carol Miller Justice Center (Dept. 81)	
	VRI	In-person	VRI	In-person
Mar 5 (Mon)	0	0	0	0
Mar 6 (Tue)	0	0	0	8
Apr 23 (Mon)	0	1	0	0
Apr 24 (Tue)	0	0	0	14
Apr 25 (Wed)	0	0	0	2
Apr 26 (Thu)	2	1	2	0
May 14 (Mon)	0	1	0	2
May 15 (Tue)	2	0	0	6
May 16 (Wed)	2	1	0	0
May 17 (Thu)	0	1	1	0
Total	6	5	3	32
Total Events	11		35	

A total of 46 events were observed. The data was collected on paper forms in the courtroom and then entered into Qualtrics and exported to SPSS for analysis.

Limitations

The initial evaluation plan recommended in-court observations at all participating courts. However, due to delays in equipment installation, several other changes to the original implementation plan, and the prohibitive costs associated, in-court observations were conducted only at Sacramento. Additionally, although researchers scheduled ten days of observation time, very few VRI events occurred on these days.

Results

During the 10 days of observations, SDSU researchers were able to observe a total of 46 interpreted events. Of the 46 events observed, 37 were interpreted in-person and nine were interpreted using VRI.

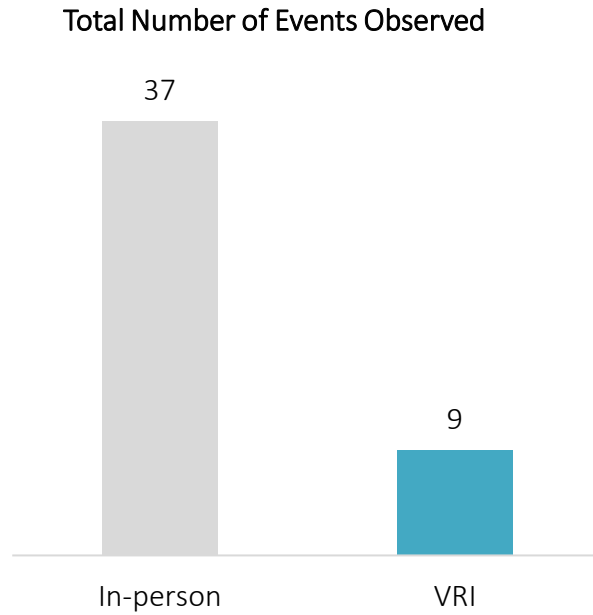

LOCATION AND VENDOR IN VRI EVENTS OBSERVED

Of the VRI events observed, six were observed at the Main Jail courthouse, which used Paras & Associates technology for VRI. Three VRI events were observed at CMJC, where the VRI technology was provided by Connected Justice.

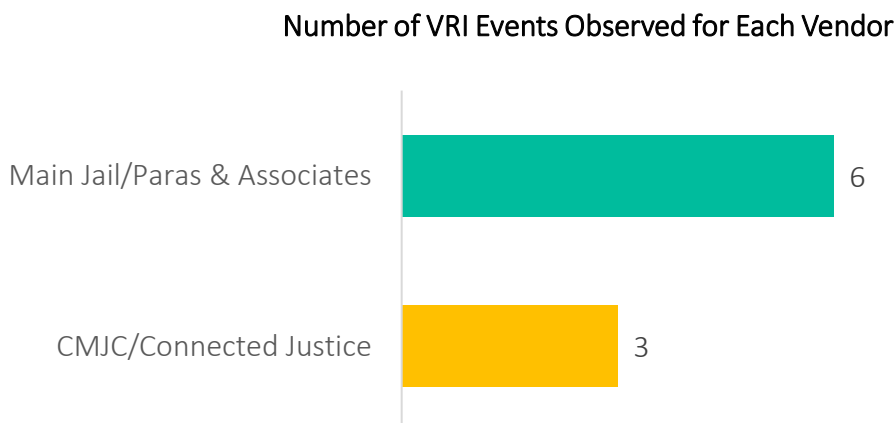

IMPLEMENTATION OF VRI RECOMMENDED BEST PRACTICES

The recommendations for best practices of using VRI in courtroom setting are from a variety of sources, including, previous JCC reports, CFI reports and documents, reports on implementation of VRI in other courtrooms in the US, and published academic literature.

Some of the recommended best practices for conducting VRI in a courtroom setting include:

- Use VRI only for events of 30 minutes or less.
- Establish a courtroom procedure to confirm that the interpreter is ready. Allow the interpreter to establish communication before the hearing, introduce all court participants, and remind all participants to speak clearly, slowly, and one at a time.
- Obtain consent to using VRI from all parties on the record.

Event Length

All of the events observed were less than 15 minutes in length.

Recommended VRI Best Practices for Judge

Establishing Consent on the Record

Of the nine VRI events observed, there were only three events where the judge asked the LEP court user to state on the record whether or not they consented to using VRI.

Asking Interpreter to State Name and Credentials on the Record

In all nine VRI events, the judge asked the interpreter to state their name and credentials on the record.

Reviewing with Interpreter Procedure for Obtaining Clarification or Missed Information

The judge did not review with the interpreter how to ask for clarification or missed information during any of the nine VRI events observed.

Reminding Court Participants to Speak Slowly, Clearly, and One at a Time.

The judge did not remind court participants to speak clearly, slowly, and one at a time during any of the nine VRI events observed.

Were recommended best practices for VRI for Judicial Officers followed?

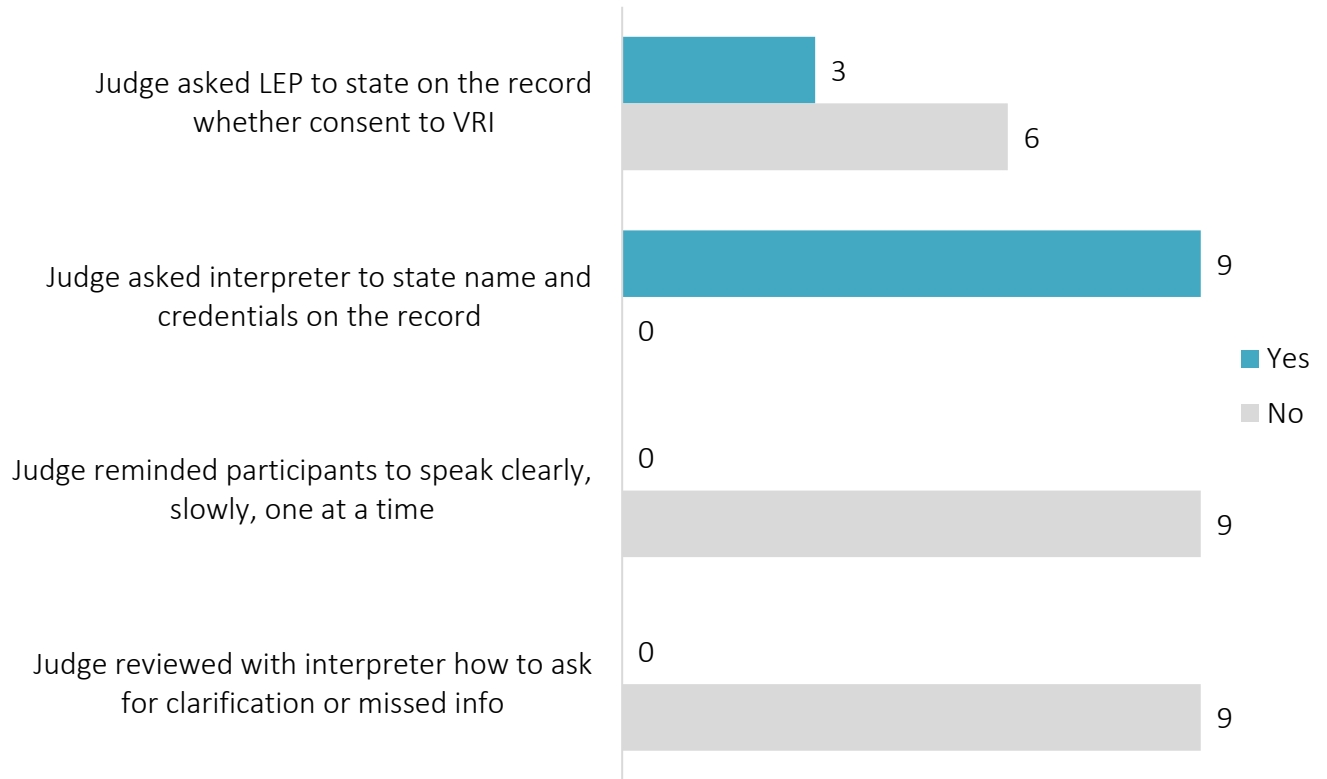

Confidential Conferencing

In two of the VRI events observed, the LEP and attorney spoke confidentially. In both of those events, the monitor showing the interpreter was turned off to maintain confidentiality.

DELAYS OR RESCHEDULING OF EVENTS DUE TO TECHNICAL ISSUES

None of the VRI events observed needed to be rescheduled as a result of technical issues. Once started, none of the VRI events observed was delayed for more than two minutes due to technical issues. One of the observed VRI events was delayed at its beginning for more than 10 minutes due to technical issues.

Observed Delays and Reschedulings

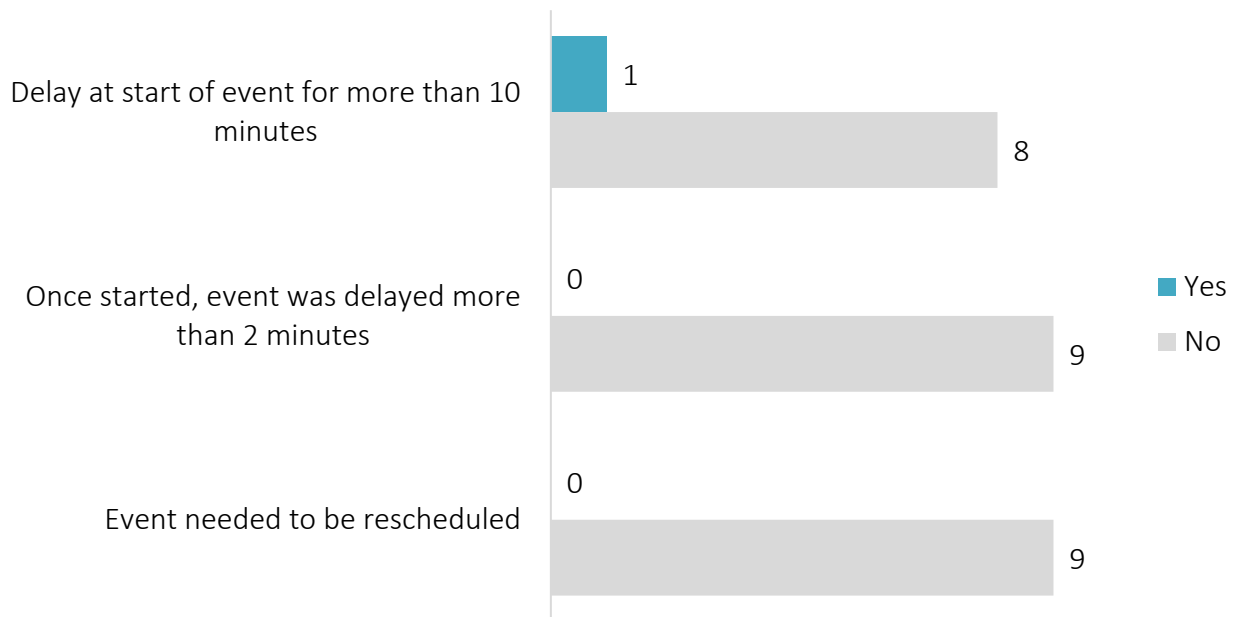

AUDIO AND VISUAL QUALITY OF VRI EVENTS

SDSU researchers noted (1) whether audio and video feeds were synchronized during the observed event, (2) whether the image on the monitor was clear or blurry, (3) whether or not there was sufficient lighting in interpreter station to see interpreter clearly, and (4) whether or not the interpreter was out of the range of the camera. All nine VRI events observed had very clear video images and sufficient lighting. In one of the VRI events observed the audio and video feeds were not synchronized, and in one event, the interpreter's mouth was out of camera range for several portions of the event.

Observed Audio and Video Quality of Events

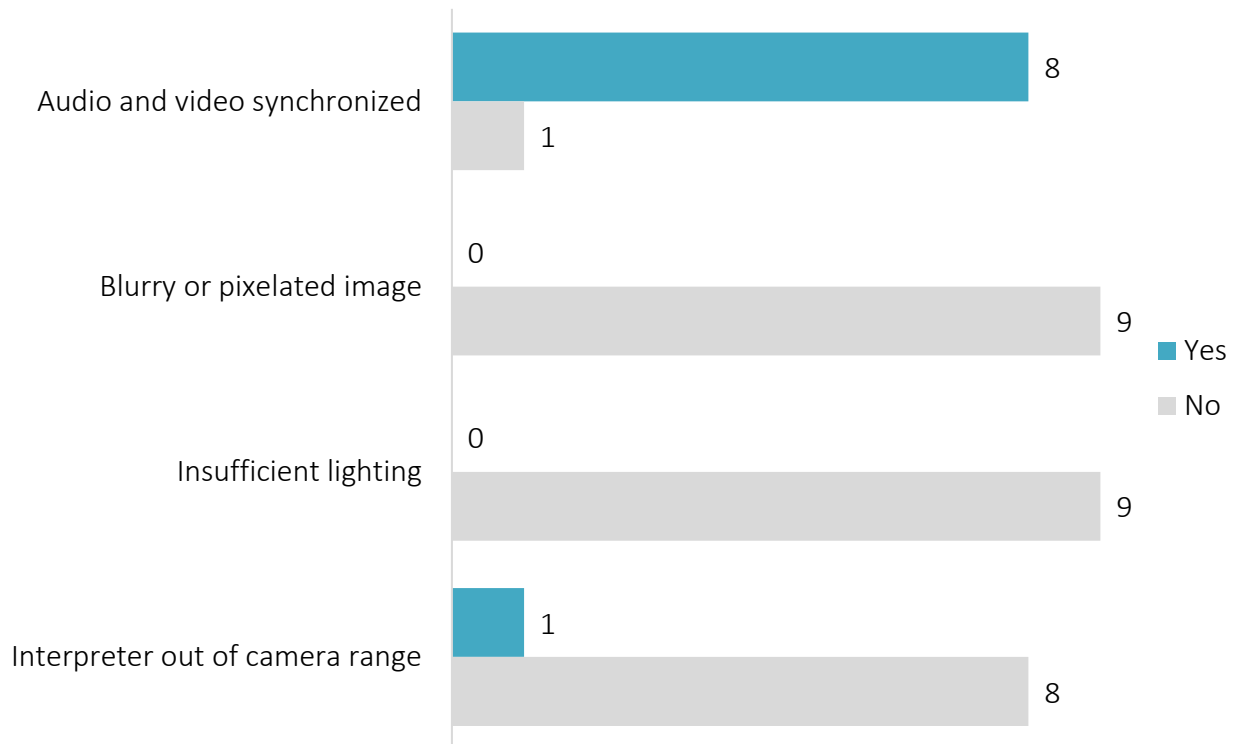

INTERPRETER INTERACTION WITH THE COURT

Interpreter Ability to Hear/Understand Court Participants

Interpreters asked one or more court participants to repeat or clarify information in five of the 46 events observed. Two of these instances were during VRI events, and three were during in-person events.

Interpreter Asked for Repeat or Clarification of Information

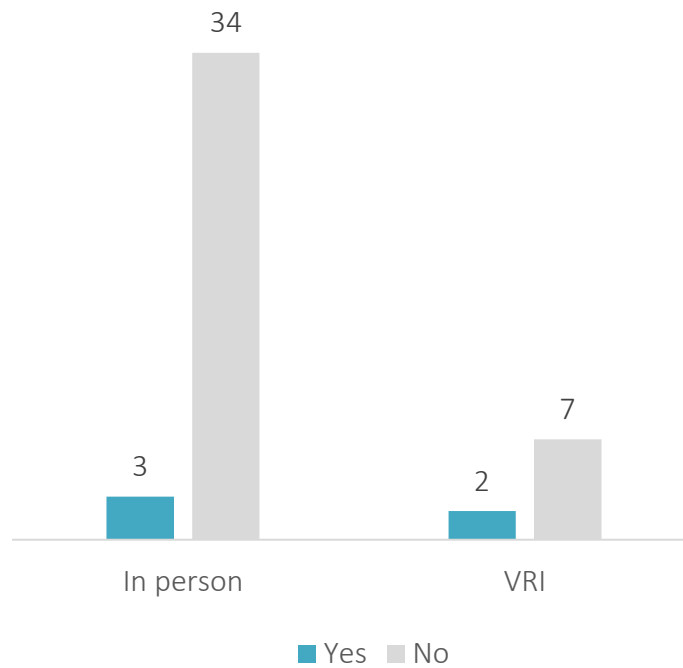

Interpreter Asked Court Participant/s to Slow Down

There were no instances of an interpreter asking court participants to slow down in any of the events observed.

More than One Participant Speaking at the Same Time

In six of the 46 events observed, there were instances of more than one participant speaking at the same time. Three of these instances were observed in VRI events, and three during in-person events.

More than One Participant Spoke at the Same Time

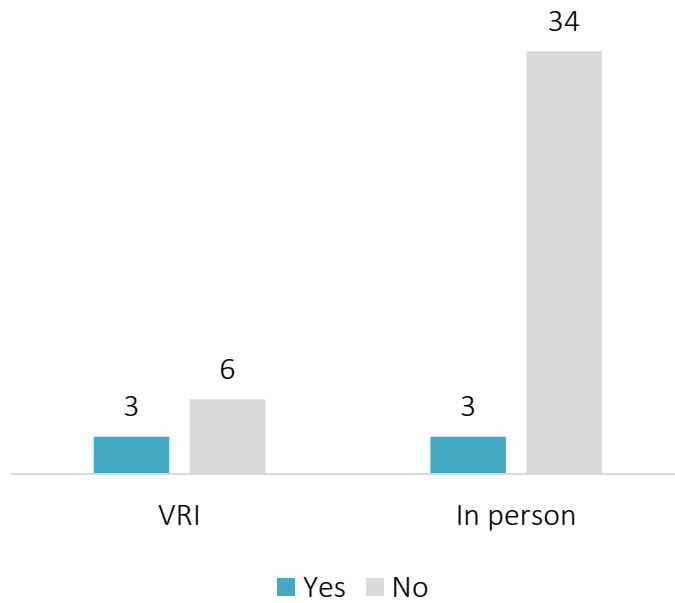

ONLINE STAKEHOLDER SURVEY

After the pilot activities were completed, an invitation to an online survey was sent to all stakeholders who participated in the pilot, including judicial officers, attorneys, court interpreters, court interpreter coordinators, court IT staff, and other court staff. Prior to survey launch, the JCC sent out an email to all potential respondents informing them of the survey and its purpose, and requesting participation. The JCC provided email addresses for all stakeholders to SDSU researchers. Email invitations with a link to the survey were sent to all stakeholders. After the initial invitation, reminders were sent to non-respondents over two consecutive weeks.

Methods

SURVEY INSTRUMENT

The goal of the online stakeholder survey was to provide additional data that would assist in answering the primary evaluation questions and to provide stakeholders an opportunity to submit more extensive anecdotal and qualitative data as compared to the brief event surveys. The survey instrument was designed by SDSU researchers with feedback from the JCC and was programmed for online administration using the Qualtrics Survey Software package. Programming and data conversion into SPSS were tested prior to survey implementation.

SAMPLE

The JCC provided SDSU with email addresses for 131 stakeholders. Email addresses were provided for 14 judicial officers, 12 attorneys, 36 court interpreters, three court interpreter coordinators, five court IT staff, 41 courtroom staff, and 20 other court staff.

SURVEY ADMINISTRATION

On July 18, 2018, a JCC representative sent an email to all potential respondents informing them of the upcoming survey and its purpose, and requesting their participation. On August 6, 2018, SDSU researchers sent an email invitation with a survey link to the 131 potential respondents, requesting their participation in the survey. Reminder emails were sent to non-respondents for two consecutive weeks (on August 9, 13, and 16, 2018). The survey link was deactivated on August 20, 2018.

LIMITATIONS

All survey research has some limitations. Some of the limitations specifically associated with online survey research include lack of survey sample representativeness, low response rates, and response submission error.

- **Survey sample representativeness:** It is not possible to know whether survey respondents have opinions or characteristics similar to potential participants who did not respond to the survey. If non-respondents do vary significantly from the population of interest in their opinions or characteristics, survey data may not be an accurate representation of the population of interest.
- **Response rates:** While response rates for online surveys tend to be low, some findings indicate that multiple email reminders and personalized email invitations increase the

response rate for online surveys. This survey used multiple reminders. However, none of the attorneys participated in the survey, so this data does not reflect the opinions of any attorneys who observed or participated in the VRI pilot events.

Results

OVERVIEW OF RESPONSES

A total of 66 respondents completed the survey. This represent an overall response rate of 50%.

Table 1. Surveys completed by each respondent group

Respondent Group	Number sent survey	Number responded to survey	Percent of total responses	Response rate for group
Judicial officer	14	5	8%	36%
Attorney	12	0	0%	0%
Interpreter	36	21	32%	58%
Interpreter Coordinator	3	2	3%	67%
IT staff	5	3	4%	60%
Courtroom staff (bailiff, clerk, etc.)	41	23	35%	56%
Other court staff	5	12	18%	60%
TOTAL	131	66	100%	50%

Number of Surveys from Each Court

Of the 66 surveys, 58% (N=38) were from respondents who work at the Sacramento Superior Court, 18% (N=12) were from respondents who work at the Merced Superior Court, and 24% (N=16) were from respondents who work at the Ventura Superior Court.

Where Events Observed

The majority of respondents to the survey had participated in or observed, on average, between one and 10 VRI events per month.

Over half of all respondents (52%) had participated in or observed VRI events at the Carol Miller Justice Center, 32% had participated in or observed VRI events at the Sacramento Main Jail Courthouse, 17% had participated in or observed VRI events at the Merced Courthouse, 12% had participated in or observed VRI events at the Los Banos Courthouse, 20% had participated in or observed VRI events at the Ventura Courthouse, and 17% had participated in or observed VRI events at the Oxnard Courthouse.

At which location(s) did you participate in or observe VRI pilot events?

[Participants could select multiple locations]

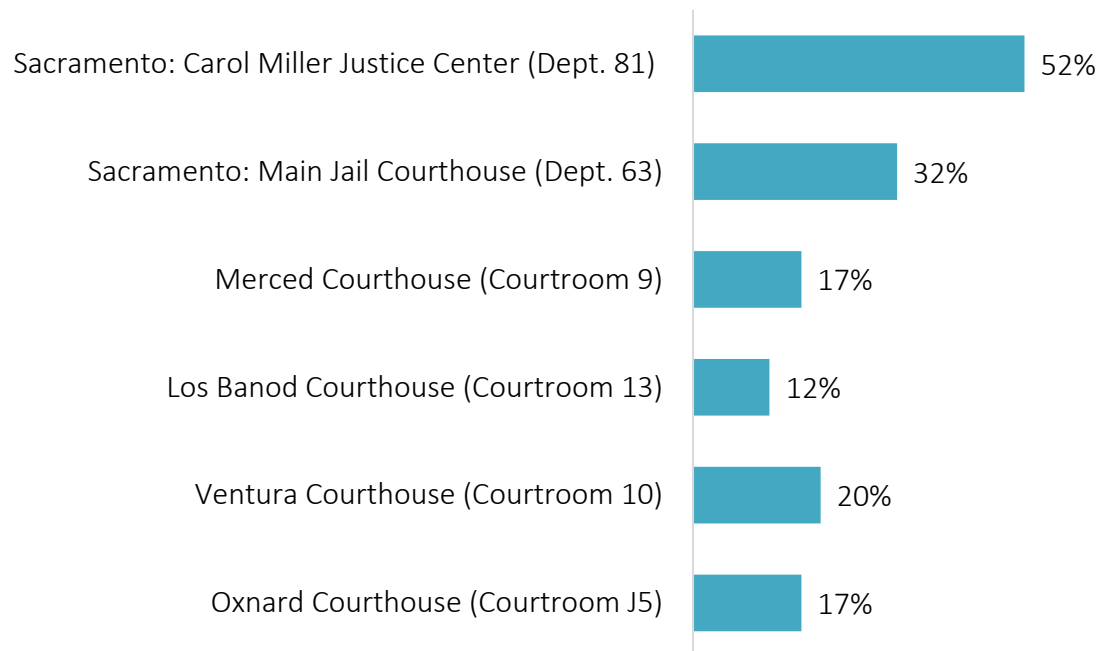

RESPONDENT PERCEPTIONS OF VRI

All respondents were asked about their prior experience with VRI. Prior to participating in the pilot, most respondents had not participated in a court event using VRI, and their opinions about VRI were varied.

Prior to this pilot, did you ever participate in any court event that used Video Remote Interpreting (VRI)?

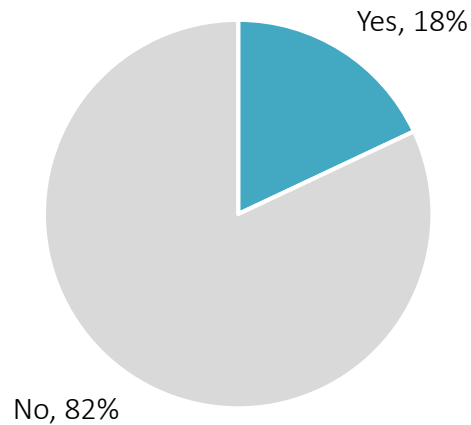

Prior to participating in this pilot, was your opinion about VRI use in a courtroom setting positive, negative, or neither?

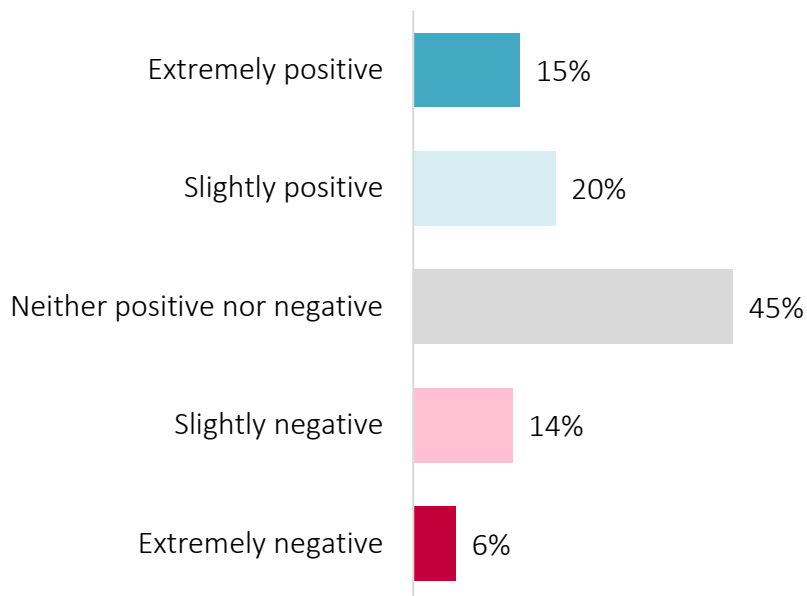

After participating in the pilot, most respondents indicated that their opinion about the use of VRI in a courtroom setting either did not change, or became more positive.

After participating in this pilot, respondent's opinion about the use of VRI in a courtroom setting:

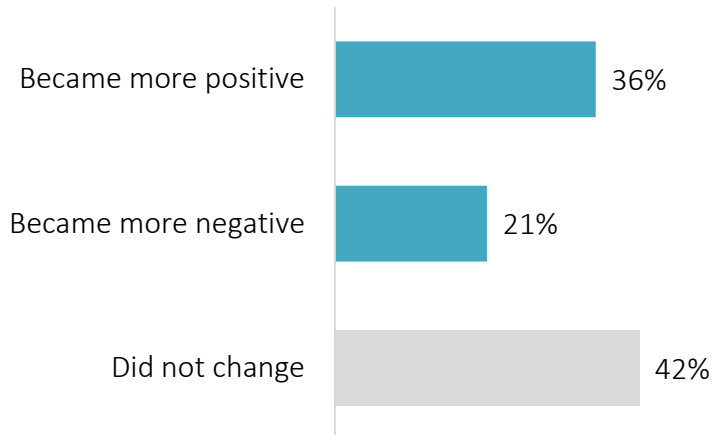

EFFECTIVENESS OF VRI

Of all respondents, 14% strongly agreed that overall, VRI provided effective interpreting to LEP court users, 42% agreed, 18% neither agreed or disagreed, 22% disagreed, and 5% strongly disagreed.

Overall, VRI provided effective interpreting to LEP court users.

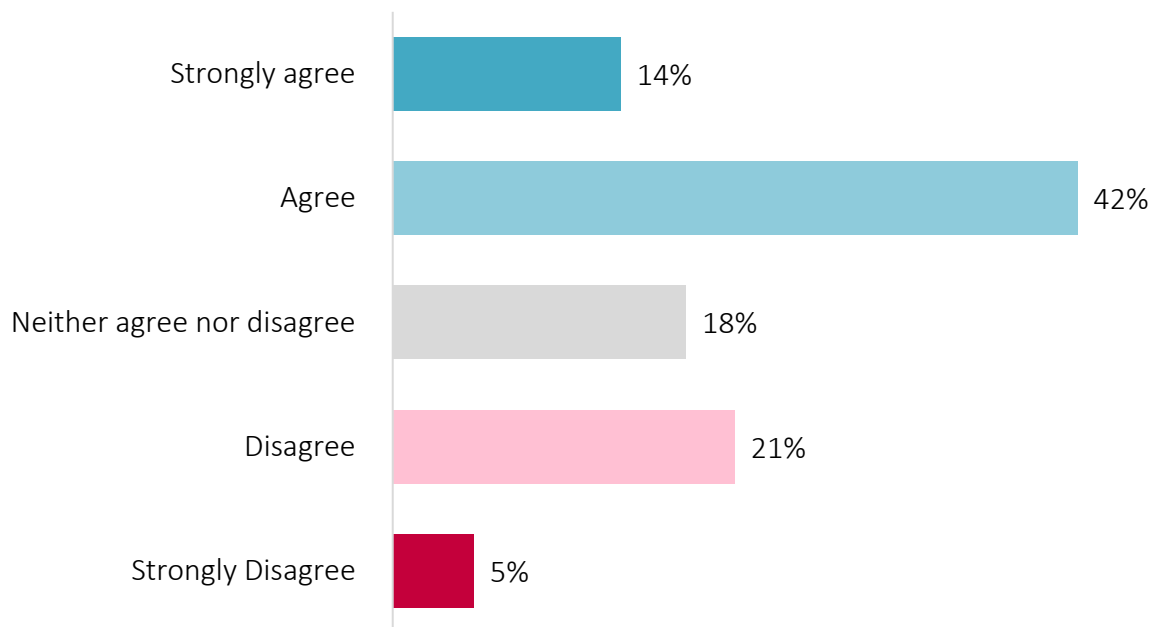

Opinions regarding the whether or not VRI provided effective interpreting to LEP court users varied significantly based on respondent group. Judicial officers were most likely to feel that VRI provided effective interpreting to LEP court users, and interpreters were least likely to feel that VRI provided effective interpreting to LEP court users ($p < .05$).

**Overall, VRI Provided Effective Interpreting to LEP court users
by Respondent Group**

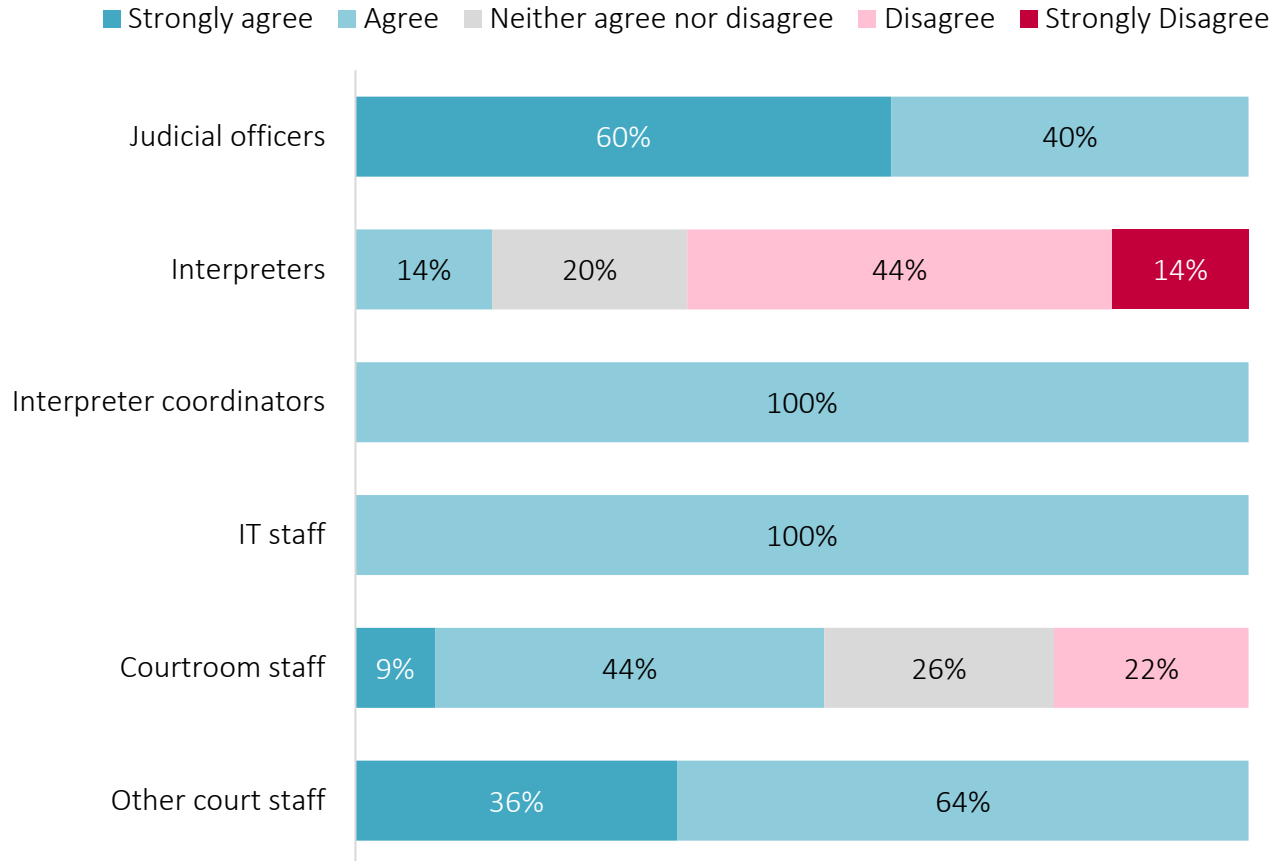

Post-pilot survey respondents were relatively evenly divided in their agreement about whether VRI with a registered/certified interpreter provides more effective interpreting than in-person interpreting with a non-certified/non-registered or provisionally qualified interpreter.

The majority of respondents felt that VRI allowed the LEP court user to meaningfully participate in court participants and that LEP users who do not want to participate in VRI should be informed that their hearing may be continued to a later date and/or necessitate a second court appearance.

Based on your participation in the pilot, how much do you agree or disagree with the following statements?

■ Strongly agree ■ Agree ■ Neither agree nor disagree ■ Disagree ■ Strongly Disagree

VRI with a registered/certified interpreter provides more effective interpreting than in-person interpreting with a non-certified/non-registered or provisionally qualified interpreter.

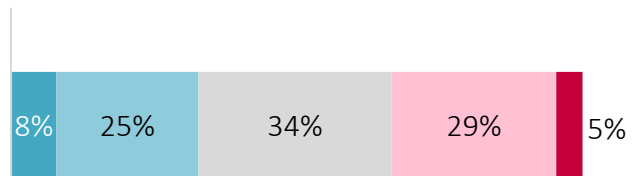

VRI allowed the LEP court user to meaningfully participate in court proceedings.

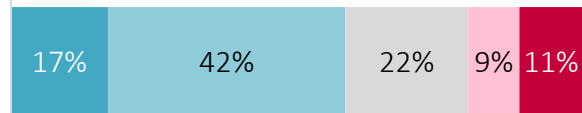

If LEP court users do not want to participate in VRI, they should be informed that their hearing may be continued to a later date in order to secure an in-person interpreter (which may necessitate a second court appearance).

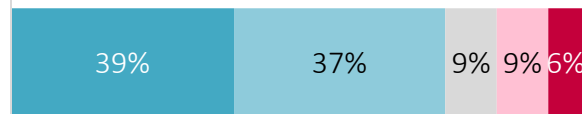

Event Length

The vast majority of respondents (81%) felt that in general during the pilot VRI was used for events of appropriate length.

Opinions of Judicial Officers, and Interpreters Regarding Effectiveness of VRI for Different Case Types and Defendant Situations

Judicial officers, attorneys, and interpreters were asked to rate the effectiveness of VRI for various case types, and across different defendant situations⁴. These respondents felt that VRI was most effective for infraction and traffic cases, and for out-of-custody defendants. The reader is advised that for many of these case types, the number of respondents is extremely small.

In general, during the pilot, how effective do you think VRI was for each of the following?

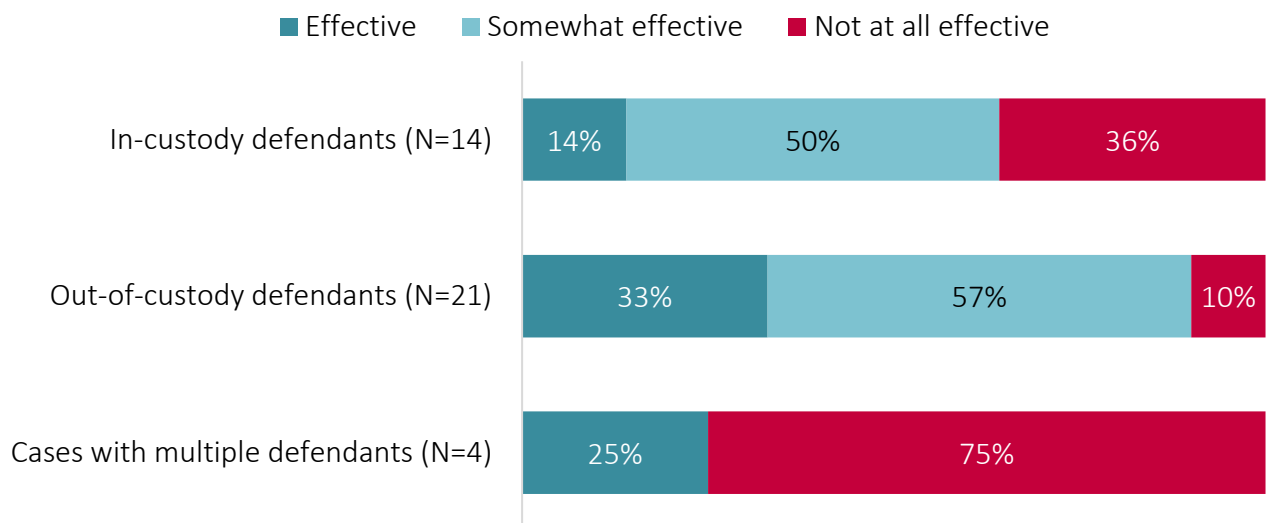

⁴ Although attorneys were included in the invitation to complete the survey, none participated.

Effectiveness of VRI for Different Case Types

In general, during the pilot, how effective do you think VRI was for each of the following case types?

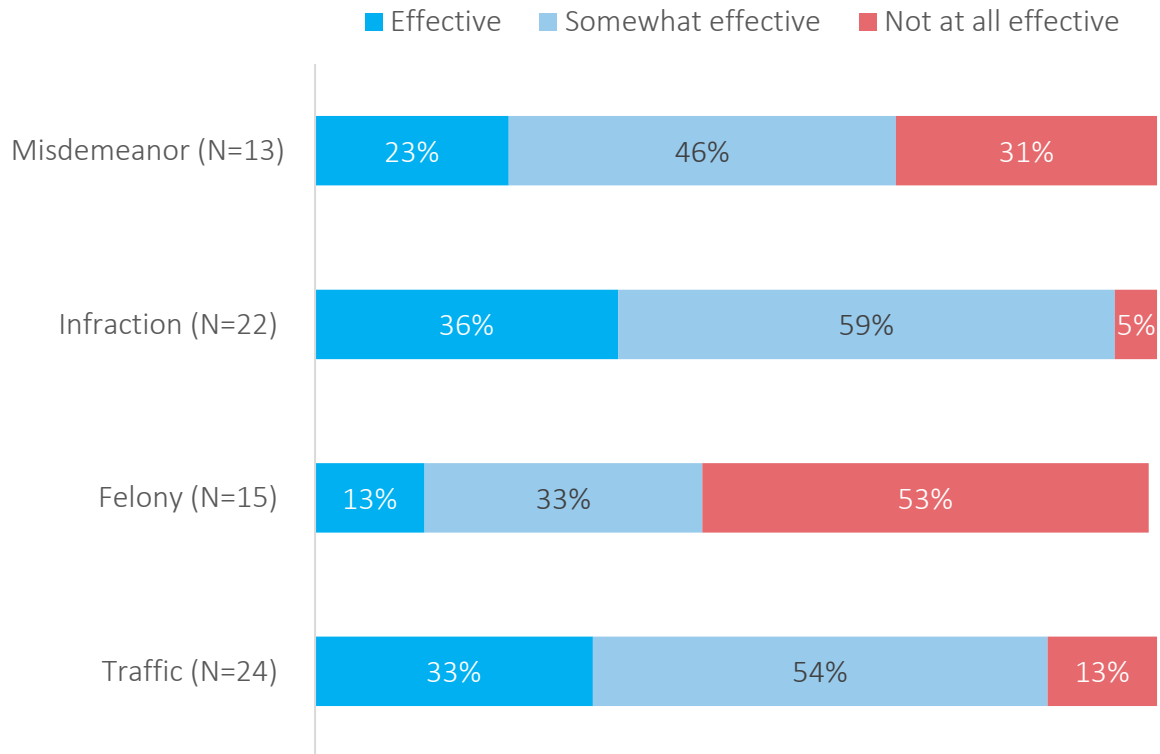

RESPONDENT OPINIONS OF DIFFERENT VENDORS

Over three-fourths (76%) of respondents had participated in or observed events that used a VRI solution provided by Paras & Associates as well as events that used a VRI solution provided by Connected Justice. Respondents that had participated in or observed events facilitated by both vendors were asked whether one or the other provided a better VRI solution.

Overall, which vendor do you feel provided better a better VRI solution, or was there no significant difference?

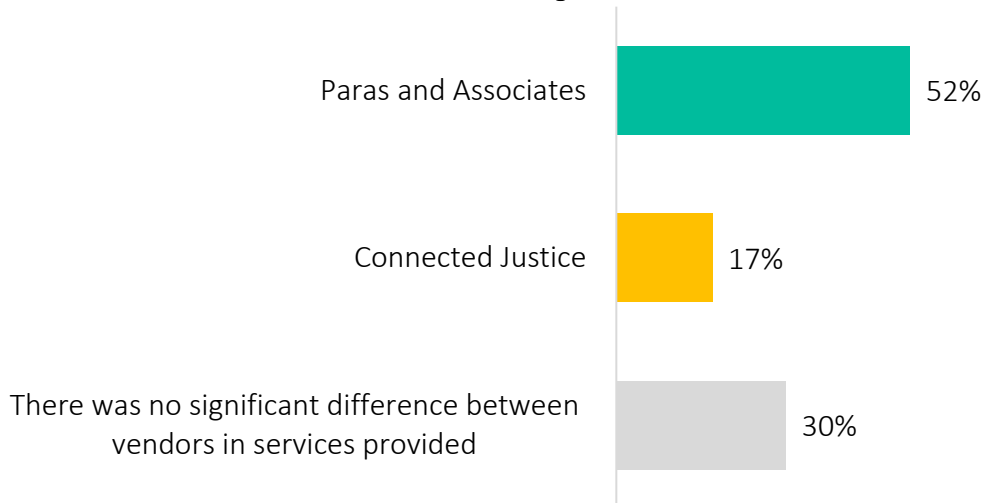

Fifty-two percent (52%) of post-pilot survey respondents felt that Paras & Associates provided a better VRI solution, 17% felt that Connected Justice provided a better solution, and 30% felt that there was no significant difference between vendors in services provided. Sixty percent (60%) of respondents felt that Paras & Associates provided better IT support.

Overall, which vendor do you think provided better IT support?

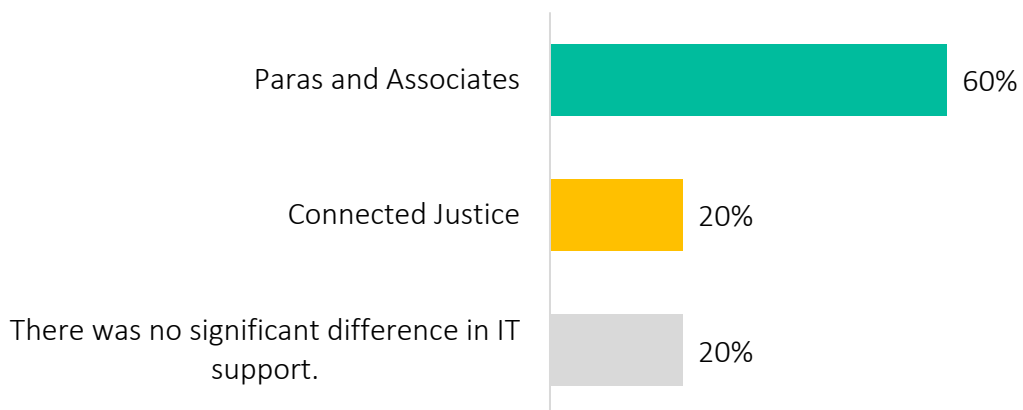

Interpreter Feedback on Vendors

Interpreters who had used both the Paras & Associates and Connected Justice solutions were asked to provide feedback on several aspects of each vendor’s solution.

Please rate the following aspects of the interpreter station setup provided by Paras & Associates.

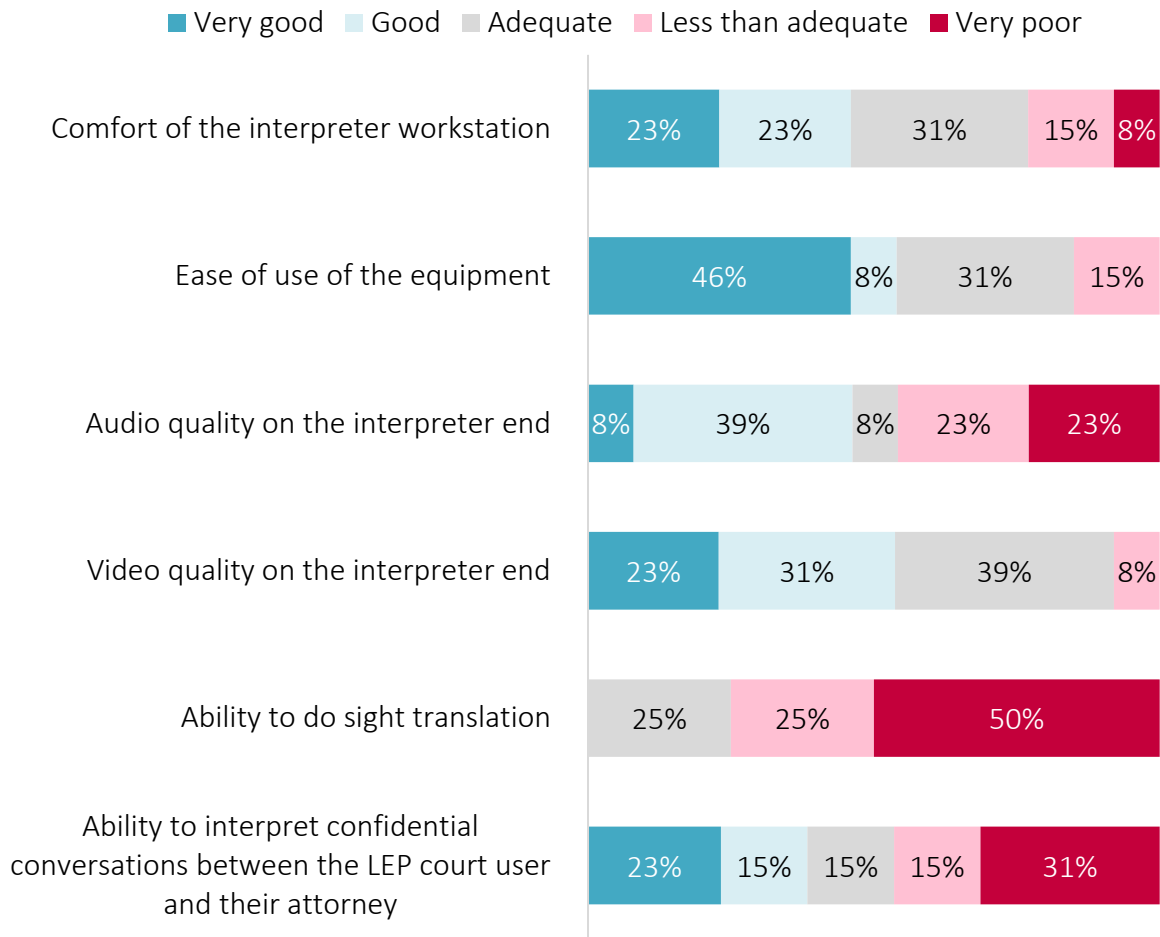

Please rate the following aspects of the interpreter station setup provided by Connected Justice.

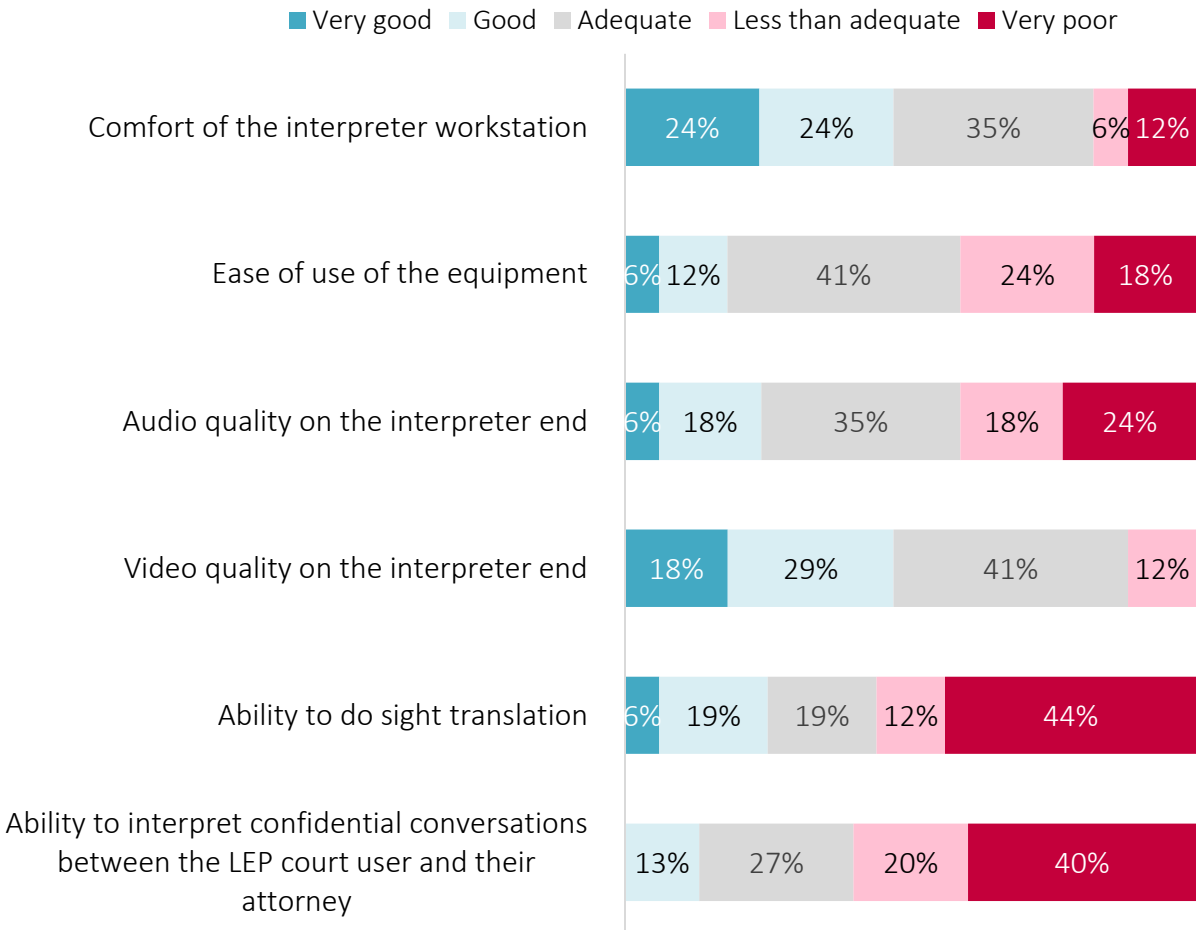

TRAINING RECEIVED ON VRI

Eighty-six percent (86%) of respondents had received training before using VRI during an actual courtroom event.

Did you receive training before using VRI during an actual courtroom event?

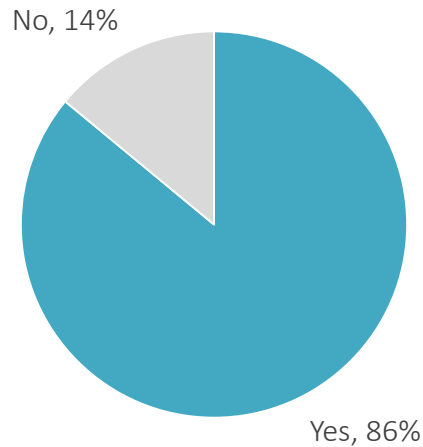

Eighty percent (80%) of those that received training felt that the amount of training received was sufficient.

Overall do you feel that the amount of training you received on VRI was sufficient?

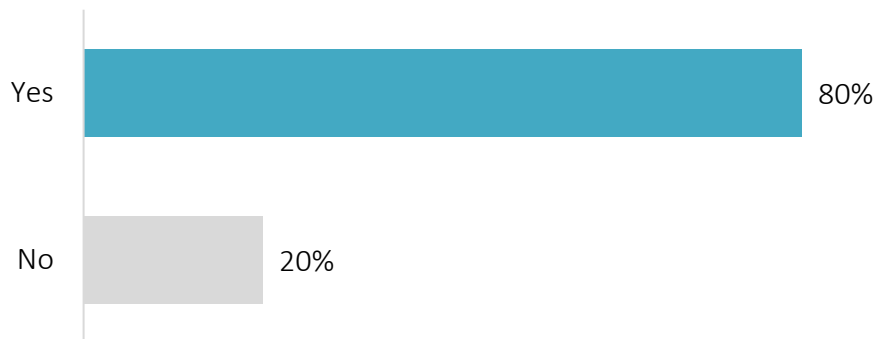

INTER-COUNTY PILOT EVENTS

Twenty-eight percent (28%) of respondents had participated in or observed events that used interpreters from a court located in a different county. The majority of these respondents felt that there was no difference in effectiveness based on the location of the interpreters for these events; 12% felt that VRI was more effective when the interpreter was located within the same county.

Effectiveness of VRI in Inter-County Events

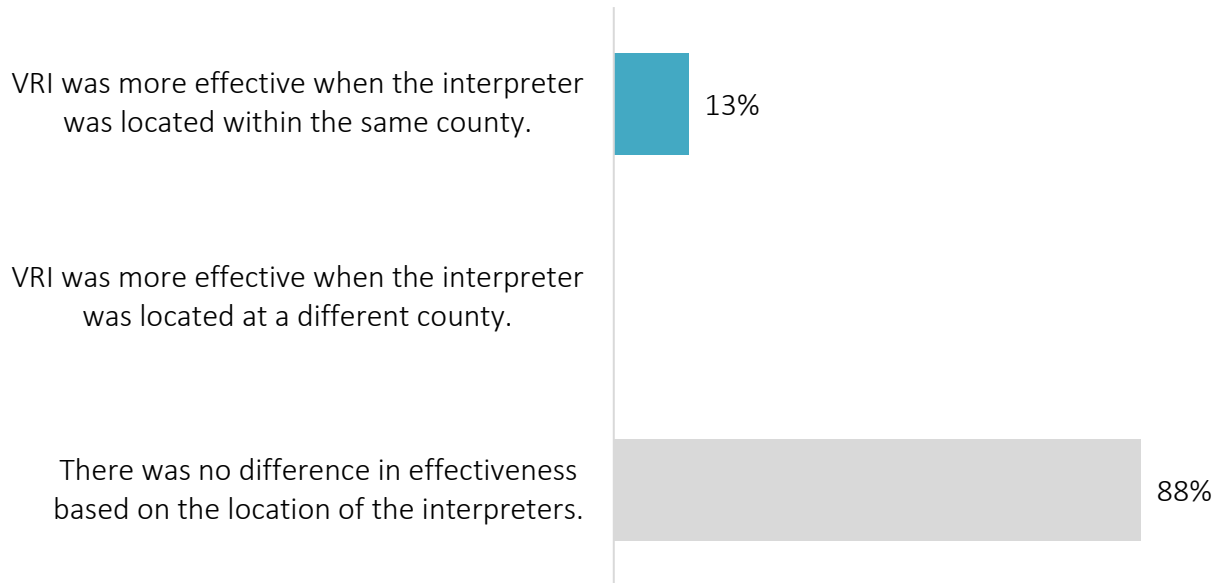

INTERPRETER COORDINATOR FEEDBACK ON IMPACT OF VRI ON SCHEDULING, USE OF REGISTERED/CERTIFIED INTERPRETERS, AND INTERPRETING COSTS

Two interpreter coordinators provided feedback. Of them, neither felt that having the option to use VRI decreased the number of reschedulings or delays caused by interpreter unavailability, neither felt that having the option to use VRI increased the use of registered/certified interpreters, and neither felt that using VRI decreased interpreting costs at their court.

Interpreter Coordinator Feedback Regarding VRI Use During Pilot

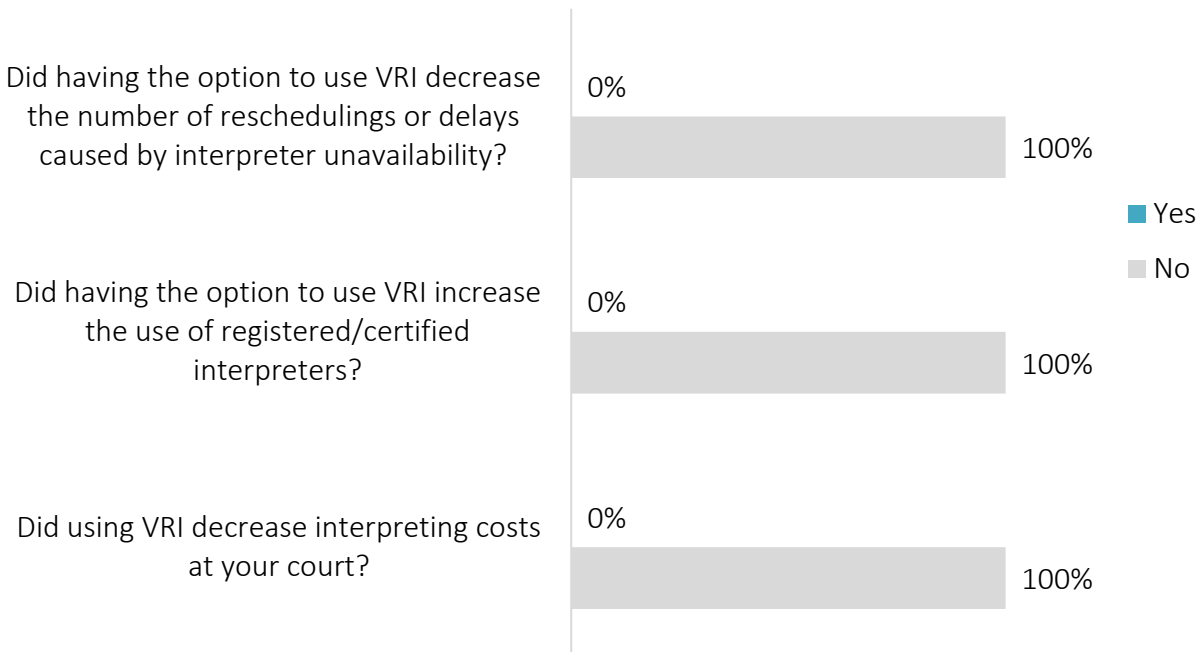

Appendix A: Literature Review

BACKGROUND

According to the 2010 US Census, California is home to the country's largest Limited English Proficient (LEP) population, with more than seven million LEP residents (Public Law Research Institute, 2013). A person is considered LEP if he or she does not speak, read, or understand English well enough to navigate the court system or participate in a courtroom proceeding (Public Law Research Institute, 2013). In an effort to address the needs of LEP and deaf or hard of hearing court users, the Judicial Council of California commissioned the **2015 Language Need and Interpreter Use Study**, and published a **Strategic Plan for Language Access in the California Courts**.

California's increasingly diverse population has rendered access to timely and qualified language interpretation a major concern across the state. When on-site interpretation services from a qualified certified or registered interpreter are not available, judges and other judicial officials must sometimes resort to either (1) appointing provisionally qualified (noncertified/nonregistered) interpreters or (2) delaying or rescheduling proceedings. Both options may pose threats to providing qualified and timely language access services and due process to LEP court users.

INTERPRETERS IN CALIFORNIA COURTS

Interpreter Qualifications

Qualified interpreters working in California courts can be either certified, registered, or provisionally qualified. A **certified interpreter** is one who has passed the Bilingual Interpreter Exam or the required exam for ASL and fulfills the corresponding Judicial Council requirements.

Certified interpreters must

- pass the Written Exam and Bilingual Interpreting Exam or the exam for American Sign Language,
- file for certification with the Judicial Council, including submitting proof of completion of the "Orientation to Working in the California Courts" online course,
- pay an annual fee,
- attend a Judicial Council Code of Ethics Workshop, and
- submit proof of 30 hours of continuing education and 40 assignments of recent professional interpreting experience every two years (Judicial Council of California, 2017).

There are currently certifying exams for the following languages: American Sign Language, Arabic, Eastern Armenian, Cantonese, Farsi, Khmer, Korean, Mandarin, Portuguese, Punjabi, Russian, Spanish, Tagalog, and Vietnamese.

Registered interpreters must

- pass the Written Exam and the Oral Proficiency Exams in both English and their non-English language(s),

- file for registration with the Judicial Council, including submitting proof of completion of the “Orientation to Working in the California Courts” online course,
- pay annual registration,
- attend a Judicial Council Code of Ethics Workshop, and
- meet the requirements developed for court interpreters regarding continuing education and professional experience.

Provisionally Qualified interpreters are non-certified and non-registered interpreters who are appointed to interpret for a given proceeding when certified or registered interpreters are unavailable. Provisional qualification is accomplished through a series of mandated steps (as laid out in the California Rules of Court, Rule 2.893) (Judicial Council of California, 2015). Whenever a non-certified interpreter is used in the courtroom, to either provisionally qualify the interpreter or find cause to permit him or her to interpret the proceeding, judges must inquire into the interpreter’s skills, professional experience, and potential conflicts of interest. Based on the findings, a provisionally qualified interpreter is designated by the judge as eligible to interpret in a criminal or juvenile delinquency proceeding for a period of six months (Public Law Research Institute, 2013).

Interpreter Employment Status

Some interpreters in the courts are employed as court staff; others are employed contractually. Roughly, two-thirds of the interpreters are court employees and one-third of them are contractors. However, the proportion of employees to contractors varies somewhat by region (National Center for State Courts, 2015).

Additionally, some interpreters are members of the California Federation of Interpreters, while others are not.

Interpreter Assignments

Interpreters are paid in increments of half-day, full-day, or night, depending on need. These categories do not necessarily indicate that the interpreter was providing services for that entire duration, but are used to describe interpreter assignment expenditures.

Court Interpreter Regions

Court interpreters who are employees of the courts are grouped into four regions that roughly correspond to the appellate districts. Staff can be cross-assigned between courts in a region, or between courts in different regions.

Table 1. Court interpreter regions

REGION 1	REGION 2		REGION 3		REGION 4
Los Angeles	Alameda	Monterey	Amador	Placer	Imperial
San Luis Obispo	Contra	San Benito	Butte	Plumas	Riverside
Santa Barbara	Costa	San Francisco	Calaveras	Sacramento	San Bernardino
Ventura	Del Norte	San Mateo	Colusa	San Joaquin	San Diego
	Humboldt	Santa Clara	El Dorado	Shasta	
	Lake	Santa Cruz	Fresno	Siskiyou	
	Marin	Solano	Glenn	Stanislaus	
	Mendocino	Sonoma	Kern	Sutter	
			Kings	Tehama	
			Lassen	Tulare	
			Madera	Tuolumne	
			Mariposa	Yolo	
			Merced	Yuba	

INTERPRETER SERVICES

The **2015 Language Need and Interpreter Use Study** (National Center for State Courts, 2015) describes interpreter use data from the period between 2009 and 2013. During this period,

- state courts provided over one million service days of interpretation,
- 72% of the interpretation was conducted in Spanish,
- 71% of service day assignments were full day, and
- language need varied across state regions (National Center for State Courts, 2015).

Data on interpreting use in California courts over the past 10 years indicates that the need for qualified interpreters will increase slowly but steadily over time, at least for the near future. Apart from Spanish (which is projected to remain stable), the report **estimated gradual growth in most LEP populations requiring interpretation** (National Center for State Courts, 2015).

The **Strategic Plan for Language Access in the California Courts** (Judicial Council of California, 2015) lays out a comprehensive plan to ensure language access for LEP court users across California. The intent of the strategic plan is to provide courts with recommendations and guidance in their efforts to expand language services to LEP users. Although the plan addresses a variety of points of contact between LEP users and the courts, emphasis is placed on focusing resources at hearings, trials, and other court proceedings (Judicial Council of California, 2015).

Two of the objectives included in the plan are

- **to increase qualified interpreter services in court-ordered/court-operated proceedings and to expand services to additional court venues, and**
- **to increase the availability of language access services to all court users.**

The plan also acknowledges the need to **build efficiencies and cost reduction** into any strategies to improve language access. Some of these efficiencies include the “thoughtful and responsible deployment of technological solutions, such as appropriate use of video remote technology” (Judicial Council of California, 2015).

VIDEO REMOTE INTERPRETING (VRI)

Video remote interpreting (VRI) is defined as a “form of interpreting where the proceedings take place at a single location (e.g., a courtroom), with the interpreter working via video link from a remote location (e.g., another courthouse)” (Braun & Taylor, 2011b). VRI uses videoconferencing technology over high-speed broadband connection or ISDN lines that carry both video and audio messages to connect an interpreter at a remote location to an LEP court user (National Center for State Courts, 2014). The use of video remote technology for interpreting purposes is growing in popularity, and it has been implemented in various settings, including medical offices, police stations, schools, and courtrooms.

In the photo on the left, an interpreter (seen on screen) interprets for an LEP user (standing at podium, with headphones). The image on the right shows VRI from the interpreter’s perspective.



VRI technology in use in a Florida courtroom. Source: Invalid source specified.

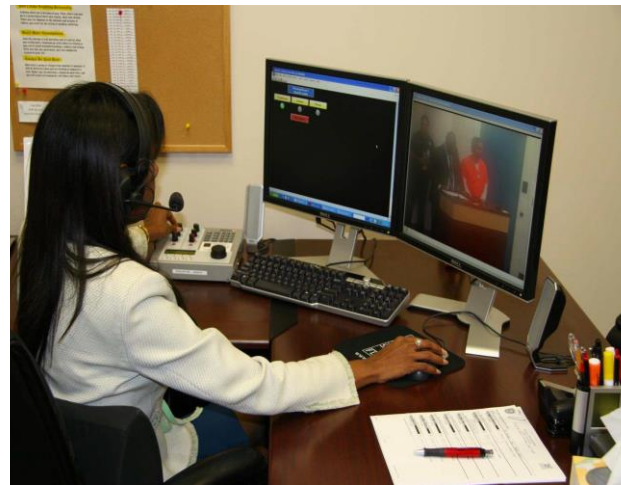

VRI technology in use by an interpreter for the Ninth Judicial Circuit Court of Florida. Source: Invalid source specified.

Potential Benefits of VRI

In theory, VRI can augment an LEP court user's access to certified and registered interpreters, especially in remote counties or in situations where interpretation is needed for an infrequently spoken language. It can also decrease wait times, and can reduce interpreter travel time and associated costs. Proponents contend that VRI expands language access, because it

- increases the availability of certified and registered interpreters and consequently minimizes waiting periods and postponements for LEP court users,
- decreases the use of less-qualified interpreters,
- decreases dismissals for failure to meet court deadlines,
- decreases the frequency of LEP court users waiving interpreter services,
- increases the number of court events interpreted, and
- decreases interpreter travel time (Judicial Council of California, 2015).

Potential Challenges of VRI

Opponents of VRI highlight perceived drawbacks associated with the use of VRI. The majority of these drawbacks pertain to the quality of interpretation, such as:

- VRI may be perceived as providing second-tier language access services (Judicial Council of California, 2015).
- Studies have shown that interpreter accuracy and level of fatigue was affected when interpreters provide services remotely, particularly when the event exceeds 15 to 20 minutes in length (Judicial Council of California, 2015).
- VRI may dilute the control an interpreter is able to exercise on ensuring accurate interpretation, and may remove the important visual context of the setting, such as nonverbal cues of event participants (Judicial Council of California, 2015).

LANGUAGE ACCESS, DUE PROCESS, AND PROCEDURAL FAIRNESS

The Due Process Clause of the 14th Amendment states, “No state shall deprive any person of life, liberty, or property, without due process of law.” In lay terms, this means that any state citizen must be able to participate in established state adjudicatory procedures.

The use of VRI in California’s courts has been highly criticized by the California Federation of Interpreters (CFI). CFI’s primary contention is that VRI is not a viable alternative to in-person interpreting, and that LEP court users provided with VRI rather than in-person interpreting are being denied due process.

However, a counter argument can be made that delays in court proceedings resulting from lack of an available qualified interpreter also infringe on the due process right of LEP litigants, as does a litigant waiving his/her right to an interpreter rather than accepting a delay in his/her hearing.

There is also debate surrounding the practice of using noncertified/nonregistered in-person interpreters when certified interpreters are not available. According to a report from Wisconsin, “when a court uses an unqualified interpreter or no interpreter at all, the result is denial of access to court proceedings” (Committee to Improve Interpreting and Translation in the Wisconsin Courts Report to the Director of State Courts, 2000). This report further contends that proceeding with an unqualified interpreter incurs a serious loss of accountability, based on poor communication, omitted, or summarized testimony, an incomplete record, unnoticed ethical issues, and subsequent unnecessary appeals and dismissals. Potential conflicts of interests may arise due to untrained interpreters offering incorrect advice, or making unauthorized decisions for the LEP court user, or purposefully incorrectly interpreting LEP court users in order to bias the judge or party (Committee to Improve Interpreting and Translation in the Wisconsin Courts Report to the Director of State Courts, 2000). All of these challenges demonstrate the difficulty of defining appropriate due process for LEP court users.

POSITION OF THE CALIFORNIA FEDERATION OF INTERPRETERS

The California Federation of Interpreters (CFI) functions as both a professional association and a labor union for interpreters in the state. While CFI does not represent all court interpreters in California, they do represent the majority of the court-employed interpreters (as opposed to independent contractors). CFI has published several documents expressing their concerns about VRI.

Video Remote Interpreting Position Statement (September 2013)

CFI provided its initial recommendations regarding the implementation of VRI in a position paper released in September 2013. The paper recommended an in-depth review of VRI prior to any implementation, the development of appropriate use guidelines (which incorporated input from

interpreter representatives) and implementation of pilot projects using VRI outside of court proceedings before attempting implementation in court events (California Federation of Interpreters, 2013).

This position paper also posited that VRI compromises meaningful language access in a variety of ways. CFI stated the remote location of the interpreter might impede “complete and accurate” interpretation due to factors such as audibility, visual orientation and extra-linguistic communication cues, access to documents, access of the LEP user to the interpreter and vice-versa, and ability to maintain confidentiality. CFI argued that VRI also involves extensive up-front equipment costs, which does not mitigate all of these challenges.

The position paper also contended that VRI might not be suitable due to the environment of the state courtrooms, which were described as “often noisy and chaotic.”

Court Interpreter Employee Bargaining Region 3 Side-Letter on VRI

In August 2014, CFI and Region 3 ratified a side-letter addressing VRI. This agreement included specific recommended guidelines for assigning a case to VRI. Cases deemed appropriate included

- events expected to last 30 minutes or less,
- non-complex, non-evidentiary events, and
- events that cannot be delayed (arraignments for in-custody hearings, bond review hearings, bail reductions, and temporary restraining orders).

The letter also recommended that VRI be used generally in consecutive interpreting and should include an initial pre-use instruction with participants (Ratified VRI Agreement between Region 3 and CFI, 2014).

PUBLISHED RESEARCH ON VRI

The term ‘remote interpreting’ is used by some researchers to mean any situation where an interpreter is located remotely, whether they are communicating with the LEP court user and court by audio only, or by both audio and video. Some researchers also include scenarios where both the interpreter and the LEP court user are remote, either in the same location or in separate locations. As much as possible we have tried to focus our review on research conducted about situations where the interpreter is in a remote location and is communicating with the court and the LEP court user (who are in the same location) via a video connection. However, we have included some research studies using other configurations when findings seem to be generalizable to VRI.

Braun and Taylor (2011a) conducted two surveys of legal interpreters who had participated in video-mediated interpreting. Their study results indicated that:

- Both legal practitioners and interpreters felt that face-to-face interpreting is always preferable to any form of video-mediated interpreting.
- Interpreters’ attitudes towards VRI were likely shaped by a feeling of being excluded from the decision-making and implementation process, and by the prevalence of outdated or inadequate equipment in some institutions.

- The majority of the interpreters working in a remote location judged their interpreting performance to be of a lesser standard than they would expect in a face-to-face scenario.
- The majority of the interpreters found VRI less satisfactory than traditional face-to-face interpreting.
- Interpreters rated VRI as being less motivating, more isolating, stressful, and fatiguing than face-to-face interpreting.

In another study attempting to assess the impact of VRI on the interpreter, Braun (2013) found that turn-taking problems (overlapping speech) and omissions (loss of information) tended to occur more frequently when using VRI than when using in-person interpreting, and that cognitive processing problems were more prominent for interpreters conducting VRI.

Based on her research, Braun's recommendations for video-mediated interpreting include

- allowing a trial and error phase,
- allowing for a stage-by-stage introduction of new technology,
- offering early-stage and continuous professional training to interpreters and legal staff,
- developing guidelines/protocols describing administrative and technical procedures for all participants, and
- making provisions for situations where communication or technological breakdown occurs (Braun, 2011).

In 2014, Schaben conducted a nationwide survey of state representatives from the National Center for State Courts Language Access Coordinators Council, soliciting feedback on VRI use. Of the 33 coordinators that responded to the survey, eight were using some form of VRI for spoken languages. Survey results indicated that the adoption of VRI increased the availability of qualified interpreters. However, respondents had mixed levels of agreement about whether VRI delivered a comparable experience to in-person interpreters and about whether or not the system was user-friendly for court users and court staff, with respect to clear audio, clear video, pan/tilt/zoom capabilities, and targeted audio.¹ Schaben concluded that although VRI is a promising technological solution for providing better access to justice, its successful implementation greatly depends on proper planning, training, application, monitoring and maintenance (Schaben, 2014).

Researchers have also raised concerns about technical challenges that manifest throughout the VRI or other video-mediated interpreting process, such as

- a slight delay between signing and seeing it on camera (for ASL interpreting),
- seeing oneself on the screen,
- environmental factors like lighting and distracting backgrounds,
- fixed camera angles and positions of television screens,
- limited feedback and ability to interact with each other, and
- small TV screens that made it difficult to see each other clearly (Napier, 2011).

¹ Schaben noted that it was difficult to analyze this, as the technology in each jurisdiction had different components and features. (Schaben, 2014).

In addition to these concerns, researchers studying the use of VRI in contexts other than a courtroom (for example, during a conference), have found that:

- Remote interpreting is psychologically more tiring for interpreters than in-person interpreting (as evidenced by performance indicators) and is more stressful (Moser-Mercer, 2003).
- Interpreters' inability to develop a feeling of presence due to the fact that they could not obtain a realistic view of the room was strongly correlated to the feeling of alienation expressed by the majority of the interpreters (Moser-Mercer, 2005).

Some of the challenges of VRI implementation use are the inherent limitations to the wider applicability of VRI in legal proceedings. Other challenges, however, can potentially be mitigated through appropriate planning, training, and implementation. Findings suggest that if the VRI program is implemented using an integrative approach that includes input from all stakeholders affected, stakeholders are more likely to be amenable to using the technology and report higher rates of interpretation quality and user satisfaction.

Quality in Interpreting

The concept of quality in interpreting has been debated in the literature. Shlesinger (1997) questioned the concept of quality as it relates to interpreting. At a workshop, Shlesinger asked participants to consider what aspects of simultaneous interpreting strike them as particularly relevant to quality. Two issues emerged in the workshop: (1) quality for *whom* i.e. of the potential participants in the interactions involving an interpreter, who should be the ultimate judge of quality and (2) methodologies for studying quality-related issues. Shlesinger argued that if the goal of interpreting is to satisfy the requirements of both the speakers and the listeners, then the attainment of these goals amounts to quality. However, she argued, different users have different expectations, and therefore, quality may be understood differently. Additionally, she pointed out, listeners cannot be the sole judges of quality because they lack an understanding of the source message. Thus, smooth delivery may create false impression of high quality even when the message is distorted or a faithful rendering can be determined as flawed even if the source is incomplete (Shlesinger, 1997; Kurz, 2001).

Shlesinger's workshop participants concluded that the target text would need to be examined on three levels: (1) intertextually i.e. a comparison of the source and target text, (2) intratextually i.e. as a product in its own right and (3) instrumentally i.e. based on the target's text usefulness and comprehensibility. Shlesinger also debated the use of questionnaires, pointing out that as long as each questionnaire focuses on different variables, is formulated among different lines, and is administered to different types of target audiences, it will be difficult to compare the results (Shlesinger, 1997).

Kurz also approached the idea of quality, reviewing questionnaires that other researchers have developed and used that examined user expectations or user responses or user reactions, or a combination of the three, but also noting the lack of comparability among the individual surveys (Kurz, 2001). Though Kurz echoed Shlesinger's views on the role of users/listeners as the judge of quality, she argued that even though users may not know what is good for them, they have expectations. Kurz recommended that interpreters should try to meet the users' expectations to the best of their ability. Kurz further recommended an interdisciplinary approach of using customer

satisfaction as an indicator of quality, by comparing what customers actually received to what they expected.

Kalina argued that if quality means different things to different people (such as users at conferences, parties to legal proceedings, medical experts), it is impossible to define universal criteria that any quality interpretation can fulfill (Kalina, 2012). Criteria would vary between different interpreting modes and settings, but also between and within different types of groups and users. Within the context of legal interpreting, Kalina (2012) stated that the crucial requirements are completeness, accuracy, and absolute neutrality. For sign language interpreting, Kalina said that important quality factors are visibility, adaptability, clarity of signs (finger spelling), thorough knowledge of deaf culture, and personality factors such as perceptual-motor coordination and assertiveness.

Although no universal criteria can be established to evaluate the quality of interpreting, experts recommend assessing the quality of interpreting by conducting user satisfaction surveys.

PREVIOUS USE OF VRI IN U.S. COURT SETTINGS

Below, we have documented how VRI has been used or is being used in some states, and included studies conducted on its use.

Arizona

In March 2013, VRI technology was installed at nine Yuma County court facilities (total 10 sites), which included two interpreter control rooms, six courtrooms, and two conference rooms (Schaben, 2014). In this VRI model, targeted audio was delivered through Internet Protocol (IP) video phones that provided simultaneous interpreting (*see info box on next page*) and allowed private attorney-client interviews in the courtroom at the counsel table. The model also included two-way videoconferencing and a pan/tilt/zoom camera that allowed the interpreter to control the viewpoint in the courtroom. The model also had the capability to record the source language even when it was not being broadcast through the public address system. This system allowed the attorneys to preserve the interpreter's rendition in the event of challenges to the accuracy of the source language.

As part of the evaluation process of this VRI model, a survey of the Yuma judges, interpreters, court staff, and attorneys who had used the VRI system was conducted.²

Survey respondents agreed that:

- The use of VRI increased the availability of qualified interpreters.
- VRI provided a substantially comparable experience when compared to an on-site interpreter.
- VRI system features were user-friendly for both court users and court staff.
- The use of VRI increased the availability of qualified interpreters to the two remote Justice Court Precincts.

However, judges and court staff did not feel adequately trained to manage the process without the availability of the Court Information and Technology Services staff or the Court Interpreter staff (Schaben, 2014).

MODES OF INTERPRETING

SIMULTANEOUS INTERPRETING is the rendering of one spoken language into another when running renditions are needed at the same time as the English language communication. The interpreter speaks virtually at the same time as the LEP person. The simultaneous mode is used whenever participants, most often defendants, are playing a passive role in court proceedings such as arraignments, hearings, or trials. The LEP speaker needs to hear what is being said but is not required, at that particular stage of the proceedings, to speak.

In **CONSECUTIVE INTERPRETING**, the interpreter waits until the speaker has finished before rendering speech into another language. Consecutive interpreting is a true and accurate interpretation of one language to another, spoken in brief sound bites successively, without omissions or embellishments, so that the parties can understand each other slowly and deliberately. The consecutive mode is used whenever LEP participants are playing an active role — when they must speak or respond — during examinations, cross-examinations, and other proceedings.

SIGHT TRANSLATION is providing an oral translation of document written in one language into spoken speech in another language. It is a true and accurate verbal translation of written material into the spoken form so that the parties can understand what documents written in foreign languages say.

Source: Schaben (2014)

² The researcher did not survey LEP litigants since “their ability to evaluate VRI systems is extremely limited and would not yield meaningful opinions” (Schaben, 2014).

California

We were able to locate two reports that assessed the implementation of VRI in California, one from Fresno County, and the other from Stanislaus County. In Fresno County, the California Administrative Office of the Courts conducted a pilot program through which the Superior Court provided remote interpreter service via videoconferencing (Schauffler, 2008). The courts in Fresno that received this service reported that it was beneficial. However, court staff noted the additional technology required in the courtroom might limit the generalizability of the service (Schauffler, 2008). In 2010-2011, Stanislaus County conducted a six-month pilot test of VRI for interpreting American Sign Language (ASL) in four courts. The pilot drafted VRI guidelines, measured judicial officer satisfaction, examined potential cost savings, and explored the effectiveness of available technology. The evaluation also indicated that the inclusion of VRI improved access to court certified ASL interpreters and resulted in high participant satisfaction (Judicial Council of California, 2015).

Florida

A 2010 report published by the Commission on Trial Court Performance and Accountability at the Supreme Court of Florida identified 13 circuit courts using some form of remote audio/video technology to provide interpreting services (Supreme Court of Florida Commission on Trial Court Performance and Accountability, 2010). The commission did not evaluate individual VRI systems but identified best practices for the implementation of VRI. The commission recommended expanding the use of remote interpreting technology to additional circuits in order to provide services at circuits that have little or no interpreting staff or need access to a rare language or an ASL interpreter who might reside in another circuit.

New York

Although we were unable to find any published documents regarding New York's implementation of VRI, there is evidence that it is currently being employed in the New York State Unified Court System. This evidence exists in the form of a benchcard provided to judges by the Unified Court System (New York State Unified Court System. Division of Professional and Court Services. Office of Language Access, 2015). The benchcard outlines procedural guidelines, includes a sample oath for the interpreter, and suggestions for how to determine if the interpreter is communicating effectively during the proceeding. The benchcard also asks judges to complete a "Remote Interpreting Assessment" (available online via the court intranet) at the end of each remote session.

KEY TAKEAWAYS FROM OTHER STATES USING VRI

Overall, the summaries of VRI use provided in this section demonstrate that although VRI technology is growing in popularity, the ways in which it is being used and how it is being implemented vary significantly from state to state, and sometimes even county to county. Despite these differences, there are several common themes:

- Courts generally implement VRI as a cost-effective alternative to expanding in-person interpretation services.
- Successful implementation of remote interpreting programs highly depends on the amount of planning, training, monitoring, and maintenance of the program performed during its implementation.
- VRI should benefit everyone involved, including the courts, the administrators, the interpreters, and the LEP/ASL court users.
- It is important to recognize that VRI cannot replace in-person interpretation services entirely, but that there are specific circumstances and situations where VRI can be applied appropriately and effectively.

RECOMMENDED BEST PRACTICES FOR VRI

Use of VRI by different states and research studies of VRI have produced a wealth of advice regarding best practices for overall implementation as well as for pilot tests, assignment of appropriate cases, technology, and training.

Overall Recommendations for VRI Implementation

- **Plan meticulously.** Involve judges and attorneys in identifying legal requirements and determine features that should or should not be included. Include personnel from Court Administration, Court Information & Technology Services, and Court Budget in the project team for insights into selection, purchase, installation, and implementation of new systems. Convene a secondary stakeholder group to allow judges, attorneys and other court users the opportunity for their opinions and concerns to be raised (Schaben, 2014).
- **Allow for a stage-by-stage introduction of new technology** (Braun, 2011).
- **Consider revisions to the remote interpreter payment policy**, so that the interpreters are guaranteed a minimum payment for reserving their time (Minnesota Judicial Branch, 2010).
- **Develop and document all VRI procedures.** At minimum, procedures should address pre-event and event protocols, interpreter scheduling procedures, technical procedures, roles of court staff, rights of LEP court users, informed consent procedures, and any other procedures that may be needed for a particular court's implementation. Procedural documentation should also specify who is responsible for various tasks (Braun, 2011).
- **Provide background material and case documents to the interpreter prior to each VRI event** (Judicial Council of California, 2012; Minnesota Judicial Branch, 2010).

- **Establish a courtroom procedure to confirm that the interpreter is ready** (Minnesota Judicial Branch, 2010), and to remind all participants to speak clearly, slowly, and one at a time (Braun & Taylor, 2011b).
- **Create printed materials for judges and court staff.** Suggestions include (1) a printed tri-fold or one page quick reference guide for all end users, (2) printed “how-to” benchcards (*see info box below*) for judges, judicial assistants, bailiffs, and courtroom staff, and (3) printed comprehensive visual reference guide for all stakeholders (Judicial Council of California, 2012)³. Printed materials to be used during events should include instructions regarding briefing interpreters, briefing LEP court users including a description of VRI and informed consent, and briefing other event participants regarding VRI procedures. Materials should also include (1) instructions on how to conduct introductions, (2) any needed scripts for judges to use with interpreters, and (3) a review of event rules.
- **For ASL events, brief both the interpreter and the court user on the layout of the courtroom and who is present** (Napier, 2012).

Recommendations for a VRI pilot implementation

Based on prior implementation and research, the recommendations for conducting a VRI pilot include the following:

BENCHCARDS

- Benchcards are one-sheet reminders of protocols for judges.
- Benchcard can include:
 - a brief description of events where VRI is appropriate
 - a checklist of things to consider or undertake during an event, such as:
 - checking with court staff to see that equipment is operational
 - confirming visibility and audibility of court user and interpreter
 - establishing consent for VRI on the record
 - asking everyone to inform the judge regarding any technical difficulties
 - providing a brief introduction of the case including background information and case elements in the event that the interpreter was not provided court documents prior to the event
 - describing out loud any reason for delays so remote interpreter is aware of what is happening, and
 - making sure court clerk can be heard by interpreter when administering oaths and calendaring hearings.
- Benchcards can be made available on the court website.

Source: Minnesota Judicial Branch, 2013

³ Refer to *Recommended Guidelines for Video Remote Interpreting (VRI) for ASL-Interpreted Events* (Judicial Council of California, 2012) for samples of checklists for (1) equipment operators, (2) interpreters, (3) judges, and (4) interpreter coordinators, (5) suggested language for judges to use, and (6) a self-assessment document for the interpreters.

- **Implement the pilot program in phases;** making courts that use block scheduling part of the first round, followed by those not currently using block scheduling, thus giving the second round courts time to align the business processes around remote interpreting (Vagenas, Clarke, & O'Connell, 2014).

Recommendations for Assessing Appropriateness of VRI for a Court Event

Prior to implementing VRI for interpreting, each case should be evaluated for its potential appropriateness to VRI. All parties must consent to using VRI on the record and the court should make clear that if for any reason VRI is not facilitating effective communication, any party can request that the matter be suspended and rescheduled with an on-site interpreter (Judicial Council of California, 2012).

Remote interpreting is better suited for short, non-evidentiary court proceedings, which makes it suitable for covering satellite courthouses, jails, and external court venues within a circuit. It is well-suited for proceedings such as

- arraignments,
- initial appearances,
- pleas, and
- violations of probation and status hearings.

Remote interpreting is not appropriate for

- proceedings involving multiple people, pleas, illustrations, recordings or additional courtroom accessories,
- intensive cross-examination,
- emotionally charged situations,
- proceedings when the person receiving the service has a mental illness, has an intellectual or cognitive impairment, is a minor, is heavily medicated, intoxicated or injured, is deaf-blind, or is elderly (Committee to Improve Interpreting and Translation in the Wisconsin Courts Report to the Director of State Courts, 2000; Minnesota Judicial Branch, 2010; Supreme Court of Florida Commission on Trial Court Performance and Accountability, 2010).

The JCC's Strategic Plan includes a list of the factors that should be included in the assessment of whether or not remote interpreting should be used in an event.

Recommended Minimum Technological/Operational Requirements

- The system should provide two-way video, targeted audio, and accommodate private attorney-client conferences (Schaben, 2014).
- All stakeholders (judge, defendant/respondent, plaintiff/petitioner, counsel, and prosecutor) should be able to hear the remote interpreter's voice clearly and vice versa (Judicial Council of California, 2012). All speakers should use a microphone.
- Every participant (including the interpreter) should be able to see the participants at the other location, be seen by the other, and see his/her own image (Braun, 2011).

- Operating instructions should be posted on VRI equipment (Judicial Council of California, 2012).
- Event participants should be able to exchange documents, and a separate document camera should be used (Braun, 2011).
- A scanner or computer, which accepts emailed attachments, should be available to send information to the interpreter. The interpreter can provide sight translation, if needed, using the same equipment (Judicial Council of California, 2012).
- Staff and judges should know how to get technical help. An IT support list with contact numbers for local court IT and key vendor personnel should be created (Schaben, 2014).
- Plans and protocols should be developed for technological breakdowns and communication or technological glitches (Braun, 2011). Backup plans should also be in place for system failures (Schaben, 2014).
- All courts should utilize similar remote interpreting equipment, in order to achieve a greater pool of trained interpreters (Minnesota Judicial Branch, 2010).
- Reliable technology must be used so that courts and interpreters feel comfortable using the equipment (Minnesota Judicial Branch, 2010).
- An enclosed, quiet environment or noise-controlled courtroom should be used (Supreme Court of Florida Commission on Trial Court Performance and Accountability, 2010), and the lighting in the courtroom should be good, with no backlighting on the signing individual (Judicial Council of California, 2012).

CONFIDENTIALITY

- Equipment and processes should be in place to allow attorney-client confidential conferencing.
- Before a VRI event takes place, all parties, judicial officers, court staff, and officers of the court should be told how to implement a confidential connection when needed.
- Individual handsets should be available to the attorney for confidential client-attorney conferencing, and the monitor showing the interpreter should be blocked visually from others in order to maintain confidentiality.

Sources: Judicial Council of California (2012), Judicial Council of California (2015), Minnesota Judicial Branch (2010), Supreme Court of Florida Commission on Trial Court Performance and Accountability, (2010)

Recommendations for Training

COURT PERSONNEL TRAINING

- **Train all persons who will encounter VRI.** This includes judicial officers, interpreters, interpreter coordinators, technology handlers, attorneys, and court users (Minnesota Judicial Branch, 2010; Supreme Court of Florida Commission on Trial Court Performance and Accountability, 2010).
- **Develop a plan to educate the bench about the benefits of using VRI with a certified or registered interpreter** (rather than using a traditional telephone interpreting agency) (Minnesota Judicial Branch, 2010).
- **Invite attorneys to learn about the system** and about the private attorney-client conversation feature (Schaben, 2014).

INTERPRETER TRAINING

- **Establish basic skill requirements and remote interpreter training programs that develop a core of qualified, remote interpreters.** The skills/techniques needed for remote interpreting include
 - ability to multi-task,
 - higher degree of concentration and focus,
 - ability to operate equipment and take notes while interpreting simultaneously,
 - manual dexterity, and
 - confidence to assertively manage the process and address technical difficulties, interrupt the court proceedings when words are inaudible or dropped, ask for clarification when needed, and request breaks when fatigued (Minnesota Judicial Branch, 2010).
 - Interpreter training should include information on any scripts to be used during an event, ethics, equipment use, how to respond to technological problems, and when to speak up if part of an interpretation is missed or clarification is needed (Minnesota Judicial Branch, 2010).
- In addition to early-stage training, **provide continuous professional training for interpreters** (including awareness of wider context, mastery of technology, communicative situation, and supportive techniques such as stress management) (Braun, 2011).
- **Include training information on the court website** informing interpreters about the skills required, best practices, technology used, the pitfalls of remote interpreting, and the interpreter's obligations in VRI (Minnesota Judicial Branch, 2010).

Recommendations for Implementation Assessment

At regular intervals, all stakeholders involved in the VRI program should be asked to provide feedback on its implementation and use. All feedback should be reviewed by parties overseeing the VRI implementation.

Appendix B: Evaluation Plan

To our knowledge, there are no existing quality assurance rubrics for analysis of in-person interpretation to assess whether it is, in fact, providing effective communication and/or due process to LEP court users. Thus, there really is no “benchmark” with which VRI can be compared or evaluated. The literature on assessment of interpreting reflects ongoing debate regarding the definition of quality and which party (the interpreter, the recipient, or an external observer) should assess quality. **This study assumes that all certified/registered interpreters are qualified to provide equally effective interpreting services and therefore any differences detected between the two interpreting modalities are primarily structural or technical.**

INITIALLY PROPOSED EVALUATION PLAN

Multiple iterations of the evaluation plan were submitted to the JCC between September 2016 and June 2017. All of these plans were directly informed by a close examination of documents provided by the JCC, including the *Outline of Evaluation Services for the VRI Pilot Program*, and the *Backgrounder on VRI Pilot*, and specifically addressed the primary research questions included in those documents.

The initial evaluation plan recommended by SDSU was based on a randomized control trial (RCT) design in which, for a period of time (e.g., four weeks), all cases eligible for VRI would be randomly assigned to either VRI or in-person interpretation. The plan also included surveying LEP court users, and having court staff complete brief surveys after every interpreted event. This plan was presented to the JCC team on February 10, 2017.

This design required that VRI eligibility criteria follow the same elements already established by an agreement between the JCC and CFI, such as for events of short duration, non-evidentiary hearings, and non-complex cases. Data would then be analyzed to assess whether or not there was a statistically significant difference in the perceived effectiveness of communication provided by the two methods.

The JCC was also interested in assessing whether or not quality or effectiveness of VRI varied significantly across multiple other variables, including:

- Case type
- Event type
- Vendors
- Technology used
- Language

However, the JCC did not feel that an RCT design would be possible in the pilot. Instead, VRI cases were assigned to specific time periods (certain weeks or days), and in-person interpreting was conducted during other time periods. Each court implemented VRI to best suit its scheduling and structural needs.

Although data was collected on some of these variables, SDSU researchers conveyed to the JCC that without random assignment of each variable, it would not be possible to determine with absolute certainty whether any differences between outcomes was a direct result of the variable of interest.

KEY EVALUATION QUESTIONS⁴

All of the evaluation questions were generated, reviewed, and edited based on (1) VRI best practices gleaned during the literature review, (2) the submission and revision of several previous evaluation plans, and (3) a series of conversations and meetings with key JCC and court staff and the judges involved in the VRI pilot project. In conjunction with the JCC, it was determined that this study would attempt to examine whether or not VRI can provide effective communication and due process to LEP court users in specific types of court events when qualified in-person interpretation is not available; and whether implementation of VRI improves access to language services to LEP court users (defined as expediency or shortened delays in obtaining interpretation services from certified/registered interpreters and/or improved access to certified/registered interpreters).

The primary evaluation questions were:

1. Do intercept surveys of judges, LEP court users, court staff, and interpreters indicate a significant difference in perceived effectiveness between the two interpreting modalities?
2. Does an analysis of observation data of VRI and in-person interpretation of court events indicate a significant difference between the two modalities as far as length of event (for traffic cases only), number of times interpreters requested information to be repeated or number of times interpreters requested that any event participant slow down?
3. Do stakeholders believe the VRI solutions implemented during the pilot provided effective communication and representation of LEP court users?
4. Did the implementation of VRI during the pilot increase the use of certified/registered interpreters?
5. Did the implementation of VRI at the three pilot sites reduce the amount of delays and or rescheduling for LEP court user events?
6. Did the implementation of VRI during the pilot period result in any cost savings for participating courts?
7. Did the quality or effectiveness of VRI vary significantly across sites, vendors, event length, or language?

⁴ The final evaluation questions and evaluation plan were submitted to the JCC as Task 2 and Task 3 Deliverables on July 18, 2017 and July 25, 2017, respectively.

DATA SOURCES

In order to answer these questions, the evaluation plan included the following data collection activities:

1. Brief event surveys to be completed by judicial officers, interpreters, LEP court users, and court staff immediately after each interpreted event during the pilot.⁵
2. On-site observations of VRI and in-person events by SDSU researchers, using an observation rubric
3. A post-pilot online survey of key stakeholders, including judicial officers, attorneys, interpreters, and court staff who participated in the pilot.
4. A review of scheduling data (to be collected and provided by participating courts).

All data collection instruments were reviewed and edited based on feedback provided by the JCC.

Table 1 below outlines the key evaluation questions as well as data sources for each question.

Table 1. Key evaluation questions and data sources

KEY EVALUATION QUESTIONS	DATA SOURCES
A. Do intercept surveys of judges, LEP court users, court staff, and interpreters indicate a significant difference in perceived effectiveness between the two interpreting modalities?	Intercept surveys of judges, LEP court users, interpreters, courtroom staff, court interpreter coordinators, and IT staff conducted at each event (both modalities)
B. Does an analysis of observation data of VRI and in-person interpretation of court events indicate a significant difference between the two modalities as far as length of event (for traffic cases only), number of times interpreters requested information to be repeated or number of times interpreters requested that any event participant slow down?	On-site observations of both VRI and in-person interpreted courtroom events
C. Do stakeholders believe the VRI solutions implemented during the pilot provided effective communication and representation of LEP court users?	Online surveys to be sent via email towards end of implementation period to key stakeholders including judges, attorneys,

⁵ The evaluation plan approved for implementation included event survey data collection during events occurring in six different courtrooms, each with different event types, three of which were provided equipment by one vendor (Paras & Associates) and three of which were provided equipment by a second vendor (Connected Justice). Events were not randomly assigned to VRI or in-person, were not randomly assigned to a specific court, and were not randomly assigned to a specific vendor.

KEY EVALUATION QUESTIONS	DATA SOURCES
	interpreters, interpreter coordinators, court IT staff, courtroom staff, and other court staff.
D. Did the implementation of VRI during the pilot increase the use of certified/registered interpreters?	Analysis of administrative, scheduling and pay data provided by courts to assess pre-and post-differences in usage patterns; online survey data
E. Did the implementation of VRI at the three pilot sites reduce the amount of delays and or rescheduling for LEP court user events?	Analysis of administrative, scheduling and pay data provided by courts to assess pre-and post-differences in usage patterns; online survey data
F. Did the implementation of VRI during the pilot period result in any cost savings for participating courts?	Analysis of administrative, scheduling and pay data provided by courts to assess pre-and post-differences in usage patterns. To be collected towards end of VRI implementation across all court sites; online survey data

PROPOSED DATA COLLECTION PLAN

This section outlines the data collection and analysis plan that was proposed to the JCC initially. The JCC and courts requested multiple changes, which are described subsequently in the report.

Site Visits

SDSU researchers planned to conduct an initial site visit to each pilot court in order to document specifics of VRI setup at each site. SDSU also planned to use these initial visits were to be used to conduct training for court staff in the administration of the online intercept surveys and data entry of paper surveys.

Event Surveys

SDSU proposed conducting event-specific intercept surveys of judges, LEP court users, court interpreters, courtroom staff, court interpreter coordinators, and court IT staff immediately after both VRI and in-person interpreted events during the pilot. SDSU researchers initially proposed administering the event surveys using tablets purchased by the JCC. SDSU researchers planned to monitor the data being collected throughout the pilot to get a sense of the number of events that data would be captured for, and to alert the JCC staff of any issues or problems with VRI equipment that may need troubleshooting.

On-Site Observations

SDSU researchers proposed conducting 10 days of on-site observations in two Sacramento courts, once the VRI equipment was installed and was working to the satisfaction of each court. SDSU planned to attend and observe both VRI and in-person interpreted events and collect data using an observation rubric.

Post-pilot Stakeholder Surveys

The data collection plan included an online survey to be sent by SDSU via email after the VRI pilot assessment period to key pilot stakeholders who participated in the pilot, including judges, attorneys, court interpreters, courtroom staff, court interpreter coordinators, involved court IT staff, and any other court staff.

Court-Provided Scheduling Data

The original data collection plan requested scheduling and cost data from the JCC. SDSU requested information about the number of events that were rescheduled or delayed due to the lack of availability of a registered/certified interpreter for a specified period of time during the pilot, for the in-person and the VRI courtrooms.

REVISIONS TO APPROVED EVALUATION PLAN REQUESTED BY THE JCC

Several revisions to the approved evaluation plan were requested by the JCC or were made based on changes to project implementation and/or information obtained during site visits, and pilot testing of the observation rubric, and event surveys.

Table 2 below outlines all changes to the evaluation plan requested by the JCC as well as the impact of those changes to the evaluation⁶.

Table 2. Changes to approved evaluation plan

Proposed Evaluation Component	Changes	Impact on Evaluation
1. Random Controlled Trial (RCT) Design.	The JCC and courts decided a RCT design was not feasible.	<ul style="list-style-type: none"> Differences between various groups could not be definitively attributed to any factors.
2. Data collection across three vendors.	One of the three vendors was not included in the pilot.	<ul style="list-style-type: none"> Only two vendors (Paras and Associates and Connected Justice) are represented in the data.
3. Vendors to switch at all sites after three months.	Vendors did not switch at any site.	<ul style="list-style-type: none"> Differences observed cannot be definitively attributed to vendor, as they may be site-related.
4. In-court observations at all three courts.	In-court observations were conducted only at Sacramento.	<ul style="list-style-type: none"> No observation data was collected at Merced and Ventura.
5. Evaluation questions.	Based on multiple site visits, as well as pilot	<ul style="list-style-type: none"> Post-pilot survey was longer than originally

⁶ These changes were further explained in the Task 6 Deliverable which was submitted to the JCC on May 4, 2018.

Proposed Evaluation Component	Changes	Impact on Evaluation
	testing of the Observation Rubric and the Event Survey, several changes were made to Evaluation Questions (Deliverable 2).	<p>thought and covered a broader array of issues.</p> <ul style="list-style-type: none"> ▪ Fewer variables were collected during observations. ▪ Data analysis plan was revised to reflect changes.
6. Control courtrooms to be established at each pilot court for data collection and comparison.	Courts did not designate a separate courtroom as “control” courtroom for in-person interpreted events. In-person events in the same courtroom were considered “control” events.	
7. Event surveys to be consistent across all courtrooms.	Individual courts wanted to “pre-populate” or exclude specific questions.	<ul style="list-style-type: none"> ▪ Individual surveys were created and printed for each courtroom and for each respondent type. ▪ Extensive re-programming of survey was required in order to allow for multiple different paper versions; skip patterns were complex and demanded additional data cleaning.
8. All event surveys to be analyzed by case and event types.	<p>Courts provided individualized list of case types and event types.</p> <p>Courts felt LEP court users would not know this information.</p>	<ul style="list-style-type: none"> ▪ Case and event types are not comparable across different courts. ▪ LEP survey responses were not analyzed at the level of case type and case event.
9. Event surveys to be conducted via tablet using online data collection.	Some courts want paper version rather than online version.	<ul style="list-style-type: none"> ▪ Courts conducted data entry of paper surveys. ▪ This introduced risk of data entry errors in the data.
10. Different event participants to answer survey about single event.	Courts felt that it would be difficult or time-consuming to ask participants to track the	<ul style="list-style-type: none"> ▪ The total number of interpreted events during pilot cannot be calculated from the data; reported the

Proposed Evaluation Component	Changes	Impact on Evaluation
	event information in the event survey.	total number of surveys that were entered.
11. Onsite observations	Lack of interpreted court events when SDSU researchers visited in March and April 2018.	<ul style="list-style-type: none"> ▪ Fewer events resulted in a small data set.
12. Equipment setup during onsite observations	CJ equipment was not installed at CMJC when SDSU researchers visited in March 2018.	<ul style="list-style-type: none"> ▪ Events that used CJ equipment are not equally represented in data set.
13. Comparison of scheduling data	Scheduling data was not available.	<ul style="list-style-type: none"> ▪ Could not report whether delays and reschedulings reduced during the VRI pilot. ▪ Could not report whether there was increase in use of registered/certified interpreters during the VRI pilot. ▪ Could not report whether there were any cost reductions during the VRI pilot. ▪ Could not report the total number of interpreted events and event characteristics (in-person and VRI) during the VRI pilot.

EVENT SURVEYS

Brief surveys were completed by judicial officers, **LEP court users, court interpreters, courtroom staff, court interpreter coordinators, and court IT staff** immediately after both in-person and interpreted events during the six-month pilot period. The purpose of these surveys was to obtain feedback from court event participants about their experiences and perceptions of the interpreting provided (either in-person or via VRI) during each event.

Methods

SURVEY INSTRUMENT

The event survey instrument was designed based on key evaluation questions and best practice recommendations (outlined in Chapter 1). **SDSU drafted event survey questions, which were reviewed by the JCC, the VRI Pilot Project Workstream, and the pilot courts. After conducting the initial site visits, further changes were made to the survey questions based on the processes observed during training.** Individualized survey versions were designed for each respondent group at each courtroom.

The LEP court user version of the survey included a question obtaining informed consent, which provided a brief description of the purpose of the survey and the evaluation as well as an option to opt out of the survey. Spanish, Punjabi, Russian, Chinese, and Vietnamese translations of the LEP court user survey were provided by the JCC. SDSU researchers formatted and individualized the five translated versions of the LEP court user survey for each court as well (see Appendix D for samples of the paper survey).

Prior the VRI pilot, all survey versions were combined into a master survey and programmed for online administration and data entry using the Qualtrics Survey Software package. Programming included locations for responses, checks for acceptable responses, respondent instructions, and necessary skip patterns. Programming and data conversion were tested prior to survey implementation.

DATA COLLECTION

Although data collection was originally planned to be conducted electronically using tablets provided by the JCC, most of the data collection was conducted using paper versions of the survey. SDSU researchers provided paper versions of the survey for each court. Individualized paper versions of the event surveys were provided to each court as needed. The link to the online survey and paper versions of the survey were provided to the courts on November 29, 2017, along with recommended planning guidelines for survey implementation.

Table 3. Format of surveys at six pilot courtrooms

SURVEY FORMAT	SAC: Mail Jail (Dept. 63)	SAC: CMJC (Dept. 81)	Merced (Court- room 9)	Los Banos (Court- room 13)	Ventura (Court- room 10)	Oxnard (Court- room J5)
Judicial Officer	Paper	Paper	Online	Online	Paper	Paper
Interpreter	Paper	Paper	Online	Paper	Paper	Paper
Court Staff	Paper	Paper	Paper	Paper	Paper	Paper
LEP court user	Paper	Paper	Both	Paper	Paper	Paper

In-person training on survey administration and data entry was provided to the Sacramento and Merced court staff. In-person survey administration and data entry training was offered by SDSU to Ventura, but was deemed not necessary by the Ventura project manager. Training materials were provided to all sites. An overview of training conducted and copies of training documents provided was provided to the JCC as part of Task 5 Deliverable. Data collection was conducted by court staff in each court from February 1, 2018 to August 31, 2018. Courts were provided with a link to an online report that tracked the number of surveys completed at each site. At courts using paper survey, court staff entered data from completed paper surveys into a link to the electronic version. The survey was closed on August 31, 2018, and data was exported from Qualtrics into SPSS. All data analysis was conducted in SPSS. The codebook and frequency distributions for the event survey data were provided to the JCC as part of Task 9 Deliverable on September 8, 2018.

POTENTIAL LIMITATIONS

1. **Missing data:** The court event survey was designed to collect data for every interpreted court event (either in-person or VRI) during the pilot period. In theory, this would result in the same number of surveys completed by judicial officers, LEP court users, and interpreters for each site; however, this was not the case. It is possible that certain court participants were unable to fill out surveys for each event they attended. Final data represents only events for which surveys were completed.
2. **Satisficing:** LEP court users were administered surveys by the same interpreters who provided them with interpreting services. In situations such as this, there is a risk of satisficing—the respondent providing answers that they feel will be better received by the interviewer.
3. **Data Entry:** There was a risk of data entry errors for courts that opted to use paper surveys. To mitigate data entry risk, SDSU researchers collected the entered paper surveys at the end of the pilot period and verified if data entry was conducted correctly, by checking 10% of surveys from each site.
4. **Recall Bias:** It is possible that court participants did not complete surveys immediately after court events, but at a later time, increasing the risk of misremembering or forgetting data points.

Results

A total of 3,856 surveys were entered by court staff. After removing incomplete and duplicate surveys, a total of 3,737 surveys remained. Of these, 2,265 (61%) were completed for in-person interpreter events, and 1,472 (39%) were completed for VRI events. **Tables 5, 6, and 7** show the distribution of complete, non-duplicated surveys for each court.

Table 4. Event surveys completed at Sacramento

Surveys Completed	Sacramento: Main Jail Courthouse (Dept. 63)			Sacramento: Carol Miller Justice Center (Dept. 81)		
	In-person	VRI	Total	In-person	VRI	Total
Judicial Officer	93	39	132	192	93	285
Interpreter	18	35	53	25	121	146
LEP Court User	10	18	28	19	104	123
Interpreter Coordinator	0	3	3	0	0	0
Court Staff	84	30	114	59	50	109
IT Staff	0	0	0	0	0	0
TOTAL	205	125	330	295	368	663

Table 5. Event surveys completed at Merced

Surveys completed	Merced (Courtroom 9)			Los Banos (Courtroom 13)		
	In-person	VRI	Total	In-person	VRI	Total
Judicial Officer	112	78	190	6	23	29
Interpreter	111	85	196	43	51	94
LEP Court User	59	70	129	3	30	33
Interpreter Coordinator	1	1	2	0	0	0
Court Staff	109	83	192	91	38	129
IT Staff	0	0	0	0	0	0
TOTAL	392	317	709	143	142	285

Table 6. Event surveys completed at Ventura

Surveys Completed	Ventura (Courtroom 10)			Oxnard (Courtroom J5)		
	In-person	VRI	Total	In-person	VRI	Total
Judicial Officer	13	93	106	15	27	42
Interpreter	379	93	472	10	40	50
LEP Court User	396	80	476	14	40	54
Interpreter Coordinator	2	1	3	0	0	0
Court Staff	379	118	497	22	25	47
IT Staff	0	0	0	0	3	3
TOTAL	1,169	385	1,554	61	135	196

CASE TYPES AND CASE EVENTS

Case Types

All respondent groups except LEP court users were asked to indicate the case type for each event survey. Of the 2,878 event surveys completed by judicial officers, interpreters, interpreter coordinators, and court staff, 1,024 were from traffic events, 815 were from infraction events, 754 were from misdemeanor events, 277 were from felony events, one was from drug court, two were from a civil event, and five were from small claims.

Table 7. Event survey: Case types

Case type	In-person	VRI	Total
Civil (other)	2	0	2
Drug court	1	0	1
Felony	174	103	277
Infraction	475	340	815
Misdemeanor	533	221	754
Small claims	5	0	5
Traffic	562	462	1,024
TOTAL	1,752	1,126	2,878

Table 8. Event survey: Case events [can be multiple cases for each event]

Case Event	In-person	VRI	Total
Admit/deny violation of probation	3	2	5
Arrest	1,388	858	2,246
Bail review	14	10	24
Case management conference	3	3	6
Conference	4	13	17
Court trial	27	4	31
Demurrer	0	0	0
Further proceedings	13	25	38
Motion	0	0	0
Order to show cause	0	0	0
Parole/Post-release community supervision hearings	0	0	0
Petition	1	1	2
Plea	36	39	75
Preliminary hearing	0	0	0
Pre-prelim	0	0	0
Pre-trial	7	1	8
Progress report	5	4	9
Proof	2	8	10
Restraining order hearing	0	0	0
Review hearing	26	16	42
Sentencing	104	75	179
Settlement conference	86	44	130
Transfer	0	0	0
Trial	24	30	54
Trial readiness	11	1	12
Violation of probation	3	6	9
Violation of probation/arrest	10	4	14
Violation of probation/arrest/sentencing	4	5	9
Walk-in	7	6	13
Other	153	97	250

Interpreter Type

Of the event surveys completed by interpreters for in-person events, 98% of the in-person surveys were completed by a certified interpreter and 2% were completed by a registered interpreter. Of those completed for VRI events, 99% were completed by a certified interpreter and 1% were completed by a registered interpreter. There was no significant difference between the proportion of certified and registered interpreters across the two modes of interpreting.

Type of Interpreter Completing Event Surveys

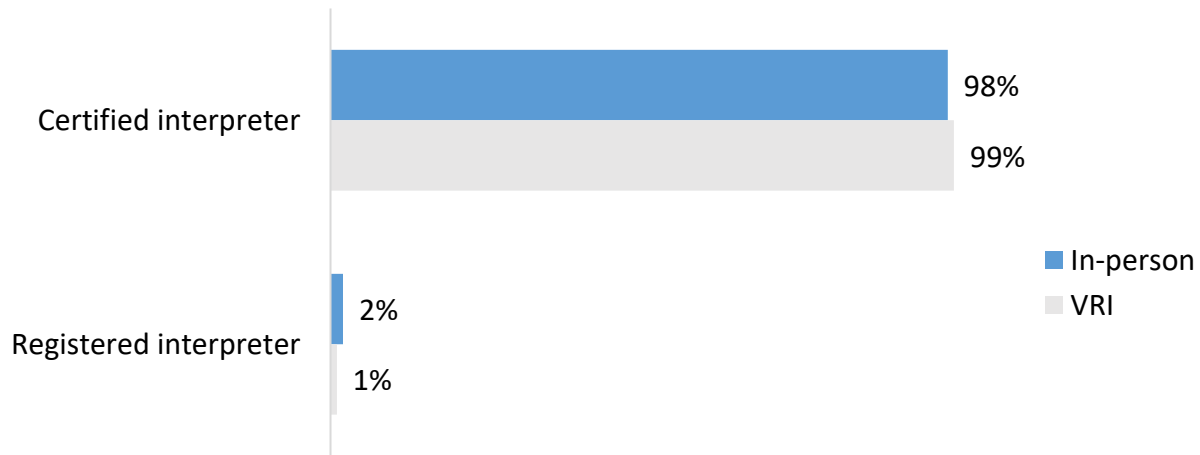

Language

Of the event surveys completed for in-person events, 88% were from events interpreted in Spanish and 12% were from events interpreted in a language other than Spanish. There was no difference in LEP court user satisfaction levels between VRI interpreted events interpreted in Spanish and those interpreted in languages other than Spanish.

Language of Interpreted Event

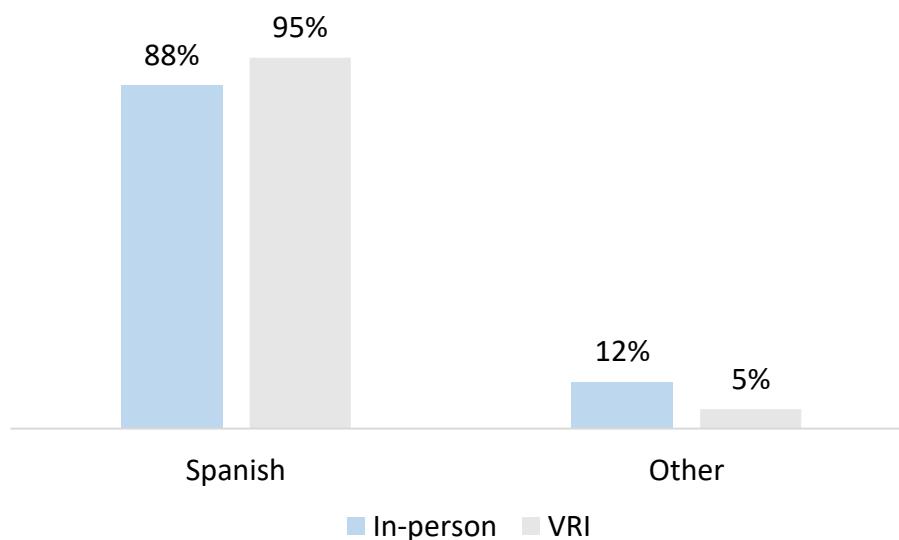
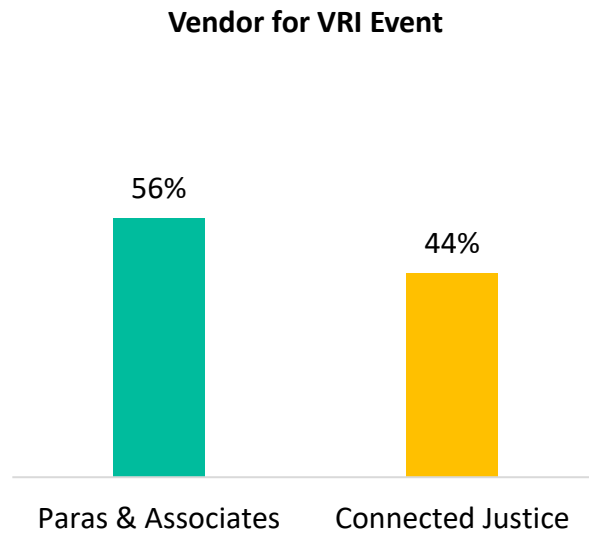

Table 2. Other languages of interpreted events

Case Event	In-person	VRI	Total
Arabic	10	0	10
Armenian	9	0	9
ASL	5	12	17
Bengali	3	0	3
Cantonese	18	0	18
Chinese [NOT SPECIFIED]	5	0	5
Dari	6	0	6
Ethiopian	1	0	1
Farsi	7	0	7
Hindi	3	0	3
Hmong	9	0	9
Laotian	1	0	1
Mandarin	47	2	49
Mien	4	0	4
Mixteco	2	0	2
Mixteco and Spanish	1	0	1
Punjabi	11	0	11
Romanian and Russian	1	0	1
Russian	56	37	93
Samoan	3	0	3
Urdu	1	0	1
Vietnamese	12	3	15
TOTAL	215	54	269

Vendor for VRI Events

Of all the event surveys, 56% were completed for events which used VRI solutions provided by Paras & Associates, and 44% were for events which used VRI solutions provided by Connected Justice.



Duration of VRI Event

The JCC recommends that events that use VRI should be less than 30 minutes in length (Judicial Council of California, 2012). Interpreters and court staff were asked about the duration of the proceeding regardless of whether it conducted by an in-person interpreter or was via VRI. Judicial officers were asked about the duration of VRI court events only. The vast majority (92%) of VRI events were less than 15 minutes in length.

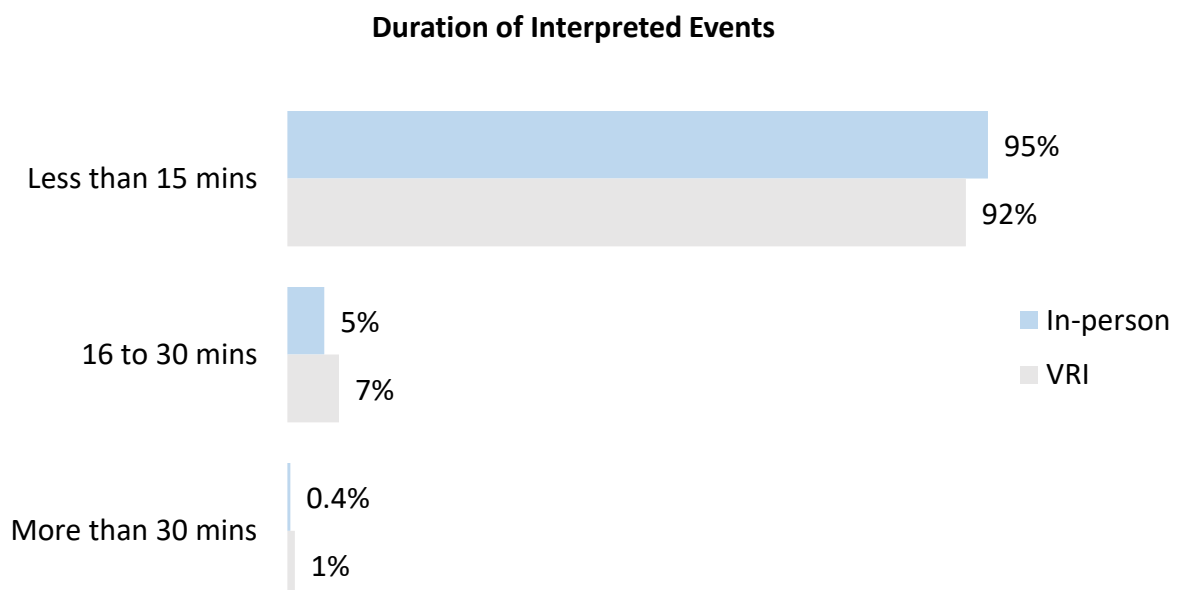

Types of Interpreting Provided During VRI Events

Event surveys completed by interpreters indicated that consecutive interpreting was provided in 89% of VRI events, simultaneous interpreting was provided in 53% of VRI events, sight translation was provided in no VRI events, and interpreting for confidential conferencing between the LEP court user and his or her attorney was provided in 5% of VRI events.

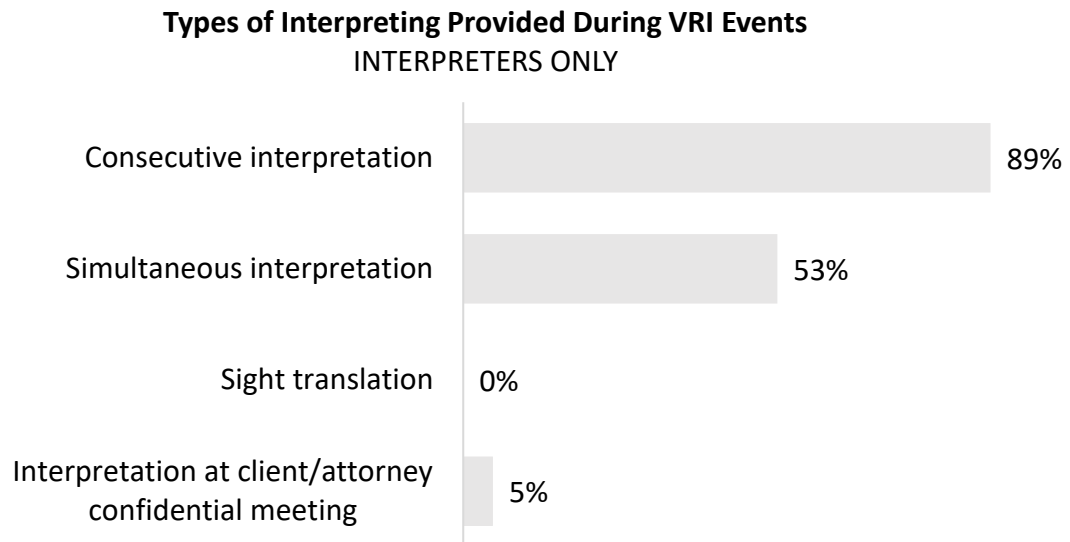

Appendix C: Technical Setup of the Pilot and Assistance to the Courts

TRAININGS CONDUCTED BY SDSU

SDSU researchers conducted trainings of court staff at Dept. 63 in the Sacramento County Main Jail Courthouse on January 8, 2018, at Dept. 81 in the Carol Miller Justice Center on January 9, 2018, at Courtroom 9 in the Merced courthouse on January 10, 2018, and at Courtroom 13 in the Los Banos courthouse on January 11, 2018. SDSU researchers conferred with the manager for court interpreting services at the Ventura court about scheduling trainings for Ventura and Oxnard courtrooms, but were informed that training was not necessary.

The training provided by SDSU reviewed (1) a description of the broad evaluation goals, (2) a description of all evaluation data collection activities, (3) the specific goals of the event survey, (4) how to complete the survey (both online and on paper), (5) how to manage collected surveys, and (6) instructions for data entry of completed surveys, including how to address missing data and skip patterns, how to complete and restart a survey, and how to go back to a previous page in the survey. Researchers also answered technical and research questions about the evaluation and the event survey specifically. During these visits, SDSU staff also participated in the JCC's training of court staff on VRI equipment and procedures and observed the equipment that was used at each site during the training.

SITE VISIT FINDINGS

According to the original data collection plan, SDSU researchers would conduct an initial site visit to each pilot court in order to document specifics of VRI setup at each site. These initial visits were also to be used to conduct training for court staff in the administration of the event surveys and data entry of paper surveys.

However, SDSU researchers only conducted on-site visits at Sacramento and Merced courts, in conjunction with the JCC. The JCC did not conduct formal training at Ventura courts, and Ventura court declined training from SDSU researchers. The initial setup checklist was completed over the phone for both the Ventura courts. SDSU researchers conducted site visits at participating courtrooms in Sacramento and Merced, using the Site Setup Checklist (submitted to the JCC as part of Task 4 Deliverable; see Appendix D for a copy of checklist). The checklist was designed based on the best practices outlined in the Literature Review and was used to document if best practices were being implemented, and if they were implemented consistently across various courtrooms. For questions unanswered during site visits, researchers followed up with court staff via phone or email. Equipment setup changed or were updated throughout the pilot, and the findings from this section may not necessarily reflect the most recent version of the setup.

Setup

The initial plan for the pilot involved switching equipment at the two Sacramento courts midway through the pilot period. However, due to delays in setup and training, equipment was not switched. At each court, there was at least one person who had experience with VRI prior to this pilot. However, this person was not necessarily involved with the implementation at both courtrooms within that court. Attorneys and the court budget department were not involved in the planning at any of the courts.

SETUP	Sac: Main Jail (Dept. 63)	Sac: CMJC (Dept. 81)	Merced (Courtroom 9)	Los Banos (Courtroom 13)	Ventura (Courtroom 10)	Oxnard (Courtroom J5)
1. Will your courtroom and setup be switched at the end of six months (or any other time period)?						
2. Do any of the court staff involved in this implementation have prior experience with VRI?	✓		✓		✓	✓
3. Did any of the following people participate in the planning of the VRI Pilot Project implementation at your court?						
a. Judicial Officers	✓			✓	✓	✓
b. Attorneys						
c. Court Administration	✓	✓	✓	✓	✓	✓
d. Technology Services/IT Staff	✓	✓	✓	✓	✓	✓
e. Budget Dept.						
f. Interpreters	✓	✓			✓	✓
g. Interpreter Coordinator	✓	✓		✓	✓	✓
h. Other: Courtroom staff	✓					

Technology

The technology used at all courts provided two-way video and had a microphone for each speaker. All setups allowed for consecutive and simultaneous interpreting, as well as client/attorney confidential communication. At Sacramento Main Jail and Oxnard, sight translation was not needed due to the nature of the courtroom and the type of cases. At the other courtrooms, though sight translation capabilities were available, courts did not plan on using them extensively.

At Sacramento Main Jail, Merced, and Ventura (all using Paras technology), the setup did not allow interpreters to see all court participants at once on their screen, but they had the option of panning or zooming the camera to focus on any court participant. At CMJC, Los Banos, and Oxnard (all using Connected Justice technology), interpreters could see pre-set camera angles of key courtroom participants. However, these cameras could not be zoomed to see lip or hand movements more clearly.

In all courtrooms, the screen displaying the interpreter was visible to all court participants. However, depending on the angle of the camera at the interpreter station, and the size of the interpreter station room, hand gestures and other contextual information (such as if the interpreter was taking notes, or adjusting switches) was not visible in a consistent manner. Depending on how the interpreter was seated or the interpreter's height, there were instances where the interpreter's mouth was not visible on the screen in the courtroom.

At CMJC and Oxnard, cases do not involve client-attorney confidential conferencing, and therefore, it was not included in the setup. In other courtrooms, the LEP court user and the attorney had a video phone that allowed them to see the interpreter and allowed the interpreter to see only them. For confidential conferencing, the main large screen showing the interpreter to the courtroom was turned off, the audio to the courtroom was muted, and the interpreter communicated with the LEP court user and the attorney only through the smaller videophone.

Though some courtrooms had a document scanner, courts did not anticipate sending documents to VRI interpreters. At CMJC and Merced, a separate terminal was set up for the LEP court users to pay their fines, or get a document translated. However, at both the locations, the terminal used only one camera and the camera had to be turned towards the user's face and then down towards the document.

TECHNOLOGY USED	Sac: Main Jail (Dept. 63)	Sac: CMJC (Dept. 81)	Merced (Courtroom 9)	Los Banos (Courtroom 13)	Ventura (Courtroom 10)	Oxnard (Courtroom J5)
4. Does the system provide:						
a. two-way video?	✓	✓	✓	✓	✓	✓
b. a microphone for each speaker?	✓	✓	✓	✓	✓	✓
5. Can the system be used for:						
a. consecutive interpretation?	✓	✓	✓	✓	✓	✓
b. simultaneous interpretation?	✓	✓	✓	✓	✓	✓
c. sight translation?		✓	✓	✓	✓	
d. client/attorney confidential meeting?	✓	✓	✓	✓	✓	✓
VIDEO CAPABILITIES						

TECHNOLOGY USED	Sac: Main Jail (Dept. 63)	Sac: CMJC (Dept. 81)	Merced (Courtroom 9)	Los Banos (Courtroom 13)	Ventura (Courtroom 10)	Oxnard (Courtroom J5)
6. Can the interpreter						
a. see all participants at the other location (judicial officer, attorney, LEP user, interpreter, witnesses, court clerk, bailiff)?		✓		✓		✓
b. see his/her own image on the monitor?	✓	✓	✓	✓	✓	✓
c. see pre-set camera angles/views of key courtroom participants?		✓		✓		✓
7. Does the interpreter have to use pan or zoom features to see key court participants?	✓	✓	✓	✓	✓	
8. Can all court participants see the interpreter?	✓	✓	✓	✓	✓	✓
9. Can court participants see the interpreter's:						
a. face	✓	✓	✓	✓	✓	✓
b. upper body	✓	✓	✓	✓	✓	✓
c. hand gestures	✓	✓				
d. the interpreter's environment for context? (e.g. can the courtroom participants tell if the interpreter is taking notes, or adjusting switches, or pressing buttons, or using the mouse?)	✓	✓			✓	✓
10. Can the interpreter hear all participants at the other location?	✓	✓	✓	✓	✓	✓
11. Can the interpreter be heard by all other participants?	✓	✓	✓	✓	✓	✓
CONFIDENTIAL CONFERENCING						

TECHNOLOGY USED	Sac: Main Jail (Dept. 63)	Sac: CMJC (Dept. 81)	Merced (Courtroom 9)	Los Banos (Courtroom 13)	Ventura (Courtroom 10)	Oxnard (Courtroom J5)
12. Can the LEP court user and their attorney speak confidentially using VRI technology if needed?	✓		✓	✓	✓	
13. Can the monitor showing the interpreter be blocked visually from others to maintain confidentiality if needed?	✓		✓	✓	✓	
DOCUMENT EXCHANGE						
14. Are court participants able to exchange documents?				✓	✓	
15. Is a separate document camera used for sight translation of documents?						
16. Is there equipment (scanner or computer) that can be used to send information to the interpreter?				✓	✓	✓

Tech Support

Courtrooms either had a contact list for local IT staff or everyone in the courtroom knew the IT person to contact. A list with the contact numbers for the vendor was only shared with the VRI project managers, super users, or IT staff. The plan for system failures for all courtrooms was to either continue the event with an in-person interpreter, or to schedule the event for a different time with an in-person interpreter.

TECH SUPPORT	Sac: Main Jail (Dept. 63)	Sac: CMJC (Dept. 81)	Merced (Courtroom 9)	Los Banos (Courtroom 13)	Ventura (Courtroom 10)	Oxnard (Courtroom J5)
17. Is there an IT support list with contact numbers for contacting local court IT?	✓		✓	✓		
a. Has this list been provided to all court staff who will be using equipment?	✓		✓	✓		
18. Is there an IT support list with contact numbers for contacting key vendor personnel?	✓		✓	✓		
a. Has this list been provided to all court staff who will be using equipment?						
19. Is there a plan in place for system failures?	✓	✓	✓	✓	✓	✓

Training

Only Merced court provided their judicial officers with the benchcard which listed when VRI may be considered, the appropriate and non-appropriate events for VRI, and a checklist to be used during a VRI event. All courts posted some instructions or information near or next to the VRI equipment, both at the interpreter station and inside the courtroom. Courts also provided a script for judicial officers to use; either specific to their courtroom or a generic one provided by the JCC.

Training was provided to judicial officers, court staff, and interpreters. At CMJC, Los Banos, and Oxnard, cases do not involve attorneys, and therefore, training was not provided to them. At least one formal training session was conducted at each courtroom, with up to 50 shorter, more informal training sessions. Courts encouraged interpreters and courtroom staff to train on the equipment whenever possible. Training sessions lasted between 15 minutes to 1.5 hours. At most courts, training also included a discussion on the appropriate types of court proceedings for VRI. Courts also provided supplemental written training materials to court personnel. These training materials were specific to individual courtrooms and included “how-to” information or scripts to be used.

Training materials were available online (on the intranet or through email) at all courtrooms. None of the courts had training materials available on their website. Written procedures were available at some courtrooms.

The training provided to interpreters varied from courtroom to courtroom. None of the courts utilized block scheduling to schedule events that needed interpretation.

TRAINING & DOCUMENTS	Sac: Main Jail (Dept. 63)	Sac: CMJC (Dept. 81)	Merced (Courtroom 9)	Los Banos (Courtroom 13)	Ventura (Courtroom 10)	Oxnard (Courtroom J5)
20. Are operating instructions posted on the VRI equipment?	✓	✓	✓	✓	✓	✓
21. Are benchcards available?			✓	✓		
22. Are judicial officers provided with a script to introduce the remote interpreter to the courtroom?	✓	✓	✓	✓	✓	✓
23. Was training in use of VRI provided to:						
a. judicial officers	✓	✓	✓	✓	✓	✓
b. court staff	✓	✓	✓	✓	✓	✓
c. interpreter coordinators	✓	✓	✓	✓	✓	✓
d. IT staff	✓		✓	✓	✓	
e. attorneys	✓		✓		✓	
f. interpreters	✓	✓	✓	✓	✓	✓
24. How many training sessions were conducted?	2	50	1-2	2	2	1
25. What was the duration of each session?	1 to 1.5 hours	1 hour	15 min – 1 hour	15 min – 1 hour	1 hour	1 hour
26. Did training include guidelines about the types of court proceedings appropriate for VRI?	✓		✓	✓	✓	✓
27. Have any supplemental written training materials been provided to:						
a. judicial officers						

TRAINING & DOCUMENTS	Sac: Main Jail (Dept. 63)	Sac: CMJC (Dept. 81)	Merced (Courtroom 9)	Los Banos (Courtroom 13)	Ventura (Courtroom 10)	Oxnard (Courtroom J5)
b. interpreters						
c. court staff						
d. IT staff						
e. other:						
28. During training, were attorneys informed about the private attorney-client conversation feature?	✓		✓		✓	
29. Have future trainings been scheduled?						
30. Is training information included on the court website or intranet?						
31. Are there written procedures specifying each of the following?						
a. pre-court proceeding protocols			✓	✓		✓
b. court proceeding protocols		✓	✓	✓		✓
c. interpreter scheduling procedures			✓	✓		
d. technical procedures			✓	✓		
e. roles of court staff				✓		
f. rights of LEP court users			✓	✓		✓
g. informed consent procedures		✓	✓	✓		✓
h. court proceeding rules			✓	✓		
i. how to conduct introductions		✓	✓	✓		
j. providing interpreter with background material and case documents before a VRI event						
k. confirming interpreter is ready		✓	✓	✓		
l. other:						

TRAINING & DOCUMENTS	Sac: Main Jail (Dept. 63)	Sac: CMJC (Dept. 81)	Merced (Courtroom 9)	Los Banos (Courtroom 13)	Ventura (Courtroom 10)	Oxnard (Courtroom J5)
32. Did interpreter training include information about:						
a. any scripts to be used during an court proceeding	✓	✓	✓	✓	✓	✓
b. ethics*				✓	✓	✓
c. technology and equipment use	✓		✓	✓	✓	✓
d. how to respond to technical problems	✓		✓	✓	✓	✓
e. how/when to speak up if part of an interpretation is missed or clarification is needed	✓		✓	✓	✓	✓
f. skills required for VRI	✓			✓	✓	✓
g. best practices in VRI						
h. risks of VRI	✓		✓	✓	✓	✓
i. interpreter's obligations in VRI	✓		✓	✓	✓	✓
SCHEDULING						
33. Is block scheduling being used?						

Appendix D: Data Collection Instruments

OBSERVATION RUBRIC

VRI PILOT: EVENT OBSERVATION RUBRIC		<input type="radio"/> Main Jail Courthouse <input type="radio"/> Carol Miller Justice Center	
Modality: <input type="radio"/> VRI <input type="radio"/> In-person			
Start Time:	End Time:	Duration: <u>MIN:SEC</u>	<input type="radio"/> Less than 15 <input type="radio"/> 16 – 30 <input type="radio"/> More than 30
COUNT			
1.	Number of times the interpreter asked any court participant to repeat or clarify information ?		# _____
2.	Number of times the interpreter asked any court participant to slow down ?		# _____
3.	Judge asked interpreter to state name and credentials on the record?	<input type="radio"/> Yes <input type="radio"/> No	
VRI ONLY			
4.	Judge reviewed procedures w/interpreter: how to ask for clarification/missed info ?	<input type="radio"/> Yes <input type="radio"/> No	
5.	Judge reminded participants to speak clearly, slowly, one at a time ?	<input type="radio"/> Yes <input type="radio"/> No	
6.	LEP court user asked to state on the record whether consent to using VRI ?	<input type="radio"/> Yes <input type="radio"/> No	
TECHNICAL PROBLEM:			
7.	Delayed start of event > 10 minutes ?	<input type="radio"/> Yes <input type="radio"/> No	
8.	Once started, delayed event > 2 minutes?	<input type="radio"/> Yes <input type="radio"/> No	
9.	Require event to be rescheduled ?	<input type="radio"/> Yes <input type="radio"/> No	
10.	Were audio and video feeds synchronized ?	<input type="radio"/> Yes <input type="radio"/> No	
ABILITY TO SEE INTERPRETER:			
11.	Blurry or pixelated image	<input type="radio"/> Yes <input type="radio"/> No	
12.	Insufficient lighting	<input type="radio"/> Yes <input type="radio"/> No	
13.	Out of range of camera	<input type="radio"/> Yes <input type="radio"/> No	
CONFIDENTIAL CONFERENCING:			
14.	Did LEP court user and attorney speak confidentially ?	<input type="radio"/> Yes <input type="radio"/> No	
	a. [IF YES] Was big screen monitor showing the interpreter blocked visually to maintain confidentiality?	<input type="radio"/> Yes <input type="radio"/> No	
15.	More than one participant spoke at the same time. (except during simultaneous interpretation)	<input type="radio"/> Yes <input type="radio"/> No	
COMMENTS:			

EVENT SURVEYS

SURVEY ID: _____

DATE DATA ENTERED: _____ INITIALS: _____

VRI Pilot Event Survey: **Judicial Officer Version**

SITE: [SITE]

ROLE: **Judicial Officer**

CASE TYPE:

CIVIL:	CRIMINAL:
<input type="radio"/> Civil Harassment	<input type="radio"/> Felony
<input type="radio"/> Domestic Violence (Civil)	<input type="radio"/> Drug Court
<input type="radio"/> Unlawful Detainer	<input type="radio"/> Misdemeanor
<input type="radio"/> Civil (Other)	<input type="radio"/> Infraction
	<input type="radio"/> Traffic

CASE EVENT: [SELECT ALL THAT APPLY]

<input type="checkbox"/> Arraignment	<input type="checkbox"/> Review Hearing
<input type="checkbox"/> Conference	<input type="checkbox"/> Sentencing
<input type="checkbox"/> Plea	<input type="checkbox"/> Trial
<input type="checkbox"/> Pre-Trial	<input type="checkbox"/> Other
<input type="checkbox"/> Preliminary Hearing	

Month of court proceeding: _____

Interpretation Language: Spanish Other: _____J1 Could you hear all court participants clearly?

- Yes
 No

J2 Could you see all court participants clearly?

- Yes
 No

J3 How effective was the interpretation provided during this court proceeding?

- Very effective
 Somewhat effective
 Not very effective
 Not at all effective

PLEASE TURN TO PAGE 2.

VRI Pilot Event Survey: **Judicial Officer Version**

J4 Was the interpreting conducted...

In-person  **END OF SURVEY, THANK YOU FOR YOUR FEEDBACK**

VRI

J5 Were the audio and video feeds synchronized?

- Yes
- No

J6 How long was the proceeding, in minutes?

- Less than 15
- 16 to 30
- More than 30

J7 Did the event need to be stopped as a result of an objection to the use of VRI?

- Yes
- No

J8 Did the VRI event allow for effective communication between the LEP court user and the courtroom?

- Yes
- No

SURVEY ID: _____
 DATE DATA ENTERED: _____ INITIALS: _____

VRI Pilot Event Survey: **Interpreter Version**

SITE: [SITE]
 ROLE: Interpreter

CASE TYPE: CIVIL: CRIMINAL:
 Civil Harassment Felony
 Domestic Violence (Civil) Drug Court
 Unlawful Detainer Misdemeanor
 Civil (Other) Infraction
 Traffic

CASE EVENT: [SELECT ALL THAT APPLY]
 Arraignment Review Hearing
 Conference Sentencing
 Plea Trial
 Pre-Trial Other
 Preliminary Hearing

Are you... a certified interpreter a registered interpreter neither

Month of Court Proceeding: _____

Interpretation Language: Spanish Other: _____

I-1 Prior to or at the beginning the court proceeding, were you able to communicate briefly with the LEP court user?
 Yes
 No

I-2 Could you hear all court participants clearly?
 Yes
 No

I-3 Could you see all court participants clearly?
 Yes
 No

I-4 If you had any reason to intervene during the court event (for example, for clarification), were you able to do so successfully?
 Yes
 No
 Not Applicable/Did not have reason to intervene

I-5 Did you have sufficient time during the court proceeding to interpret effectively?
 Yes
 No

PLEASE TURN TO PAGE 2.

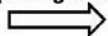

VRI Pilot Event Survey: **Interpreter Version**

- I-6 How long was the proceeding, in minutes?**
- Less than 15
 - 16 to 30
 - More than 30
- I-7 How effective was the interpretation provided during this court proceeding?**
- Very effective
 - Somewhat effective
 - Not very effective
 - Not at all effective
- I-8 Was the interpreting conducted...**
- In-person  **END OF SURVEY, THANK YOU FOR YOUR FEEDBACK**
 - VRI**



PLEASE ANSWER THESE QUESTIONS IF THIS COURT PROCEEDING USED VRI

- I-9 During this court proceeding, which of the following did you provide? (Select all that apply)**
- Consecutive interpretation
 - Simultaneous interpretation
 - Interpretation at client/attorney confidential meeting
 - Sight translation
- I-10 Prior to the court proceeding, did the court provide you with information about the case?**
- Yes
 - No
- I-11 Was the LEP court user asked to state on the record whether he or she consents to using VRI?**
- Yes
 - No
- I-12 Did the judicial officer introduce all court participants?**
- Yes
 - No
- I-13 Did the judicial officer remind all participants to speak clearly, slowly, and one at a time?**
- Yes
 - No
- I-14 Were the audio and video feeds synchronized?**
- Yes
 - No

SURVEY ID: _____
 DATE DATA ENTERED: _____ INITIALS: _____

VRI Pilot Event Survey: **Court Staff Version**

SITE: [SITE]

Role:

- Interpreter coordinator
- Courtroom staff
- IT staff

CASE TYPE:

CIVIL:	CRIMINAL:
<input type="radio"/> Civil Harassment	<input type="radio"/> Felony
<input type="radio"/> Domestic Violence (Civil)	<input type="radio"/> Drug Court
<input type="radio"/> Unlawful Detainer	<input type="radio"/> Misdemeanor
<input type="radio"/> Civil (Other)	<input type="radio"/> Infraction
	<input type="radio"/> Traffic

CASE EVENT: [SELECT ALL THAT APPLY]

<input type="checkbox"/> Arraignment	<input type="checkbox"/> Review Hearing
<input type="checkbox"/> Conference	<input type="checkbox"/> Sentencing
<input type="checkbox"/> Plea	<input type="checkbox"/> Trial
<input type="checkbox"/> Pre-Trial	<input type="checkbox"/> Other
<input type="checkbox"/> Preliminary Hearing	

Month of Court Proceeding: _____

Interpretation Language: Spanish Other: _____

S1 Could you hear all court participants clearly?

- Yes
- No

S2 Could you see all court participants clearly?

- Yes
- No

S3 How long was the proceeding, in minutes?

- Less than 15
- 16 to 30
- More than 30

PLEASE TURN TO PAGE 2.



VRI Pilot Event Survey: **Court Staff Version**

S4 Was the interpreting conducted...

- In-Person  END OF SURVEY, THANK YOU FOR YOUR FEEDBACK

VRI



PLEASE ANSWER THESE QUESTIONS IF THIS COURT PROCEEDING USED VRI

- S5 Was the LEP court user asked to state on the record whether he or she consents to using VRI?
 Yes
 No
- S6 Did the judicial officer introduce all court participants?
 Yes
 No
- S7 Did the judicial officer remind all participants to speak clearly, slowly, and one at a time?
 Yes
 No
- S8 Were the audio and video feeds synchronized?
 Yes
 No
- S9 Was there a technical problem with the VRI equipment that delayed the start of the court proceeding for more than 10 minutes?
 Yes
 No
- S10 Was there a technical problem with the VRI equipment during the court proceeding that delayed it more than 2 minutes?
 Yes
 No
- S11 Was there a technical problem with the VRI equipment that required the court proceeding to be rescheduled?
 Yes
 No

STAFF ONLY

SURVEY ID: _____
 DATE DATA ENTERED: _____ INITIALS: _____

VRI Pilot Event Survey: **LEP Court User Version** [ENGLISH]

SITE: [SITE]

ROLE: **LEP Court User**

Month: _____

This survey is part of a research project about interpreting. Participation is voluntary and your responses are completely anonymous and are not tied to any personal information. You have the option not to respond to any question that you choose. Participation or non-participation will not impact your relationship with the court. Submission of the survey will be interpreted as your informed consent to participate and that you affirm that you are at least 18 years of age.

Will you answer just a few questions about the interpreting services you received today?

- Yes
 No

L1. Could you hear all court participants clearly?

- Yes
 No

L2. Could you see all court participants clearly?

- Yes
 No

L3. How satisfied were you with the interpreting services you received at court today?

- Very satisfied
 Somewhat satisfied
 Somewhat dissatisfied
 Very dissatisfied

L4. Were the interpreting services you received today provided by:

- An interpreter who was in the courtroom with you  **THANK YOU, END OF SURVEY**
 An interpreter who was connected to the courtroom using video and audio technology?

L5. Was the equipment provided easy to use?

- Yes
 No

STAFF ONLY

Survey language: English Spanish Other: _____

STAFF ONLY

SURVEY ID: _____
 DATE DATA ENTERED: _____ INITIALS: _____

VRI Pilot Event Survey: LEP Court User Version [SPANISH]

SITE: [SITE]

ROLE: LEP Court User

Month: _____

Esta encuesta es parte de un proyecto de investigación sobre la interpretación. Su participación es voluntaria y sus respuestas son completamente anónimas y no están vinculadas a ninguna información personal. Usted tiene la opción de no responder a cualquier pregunta. La participación o no participación no afectará su relación con el tribunal. Al entregar la encuesta, usted da su consentimiento informado para participar y afirma que tiene al menos 18 años de edad.

¿Puede contestar algunas preguntas sobre el servicio de interpretación que recibió hoy?

- Sí
 No

L1. ¿Podía escuchar a todos los participantes de del tribunal con claridad?

- Sí
 No

L2. ¿Podía ver claramente a todos los participantes del tribunal?

- Sí
 No

L3. ¿Qué tan satisfecho estaba usted con los servicios de interpretación que recibió hoy en la corte?

- Muy satisfecho
 Algo satisfecho
 Algo insatisfecho
 Muy insatisfecho

L4. Hoy, el servicio de interpretación fue proporcionado por un intérprete que:

- estaba en la sala del tribunal con usted  FIN DE LA ENCUESTA, GRACIAS POR SU RETROALIMENTACIÓN
 se conectó con la sala de audiencias utilizando la tecnología de video y audio

L5. ¿El equipo fue fácil de usar?

- Sí
 No

STAFF ONLY

 Survey language: English Spanish Other: _____

SITE SETUP CHECKLIST

Deliverable 4: Evaluation Data Collection Tools [Updated]

VRI PILOT SITE SETUP CHECKLIST

COURT:	COURTROOM/VENDOR:	DATE:
Meeting Attendees:		
Key Contact Person:		
Interpreter Coordinator:		
IT Staff Person:		
Other:		
Other:		

	YES	NO	DK/ NA	COMMENTS
SETUP				
1. Will your courtroom and setup be switched at the end of 6 months (or any other time period)?				
2. Do any of the court staff involved in this implementation have prior experience with VRI?				
3. Did any of the following people participate in the planning of the VRI Pilot Project implementation at your court?				
a. Judicial Officers				
b. Attorneys				
c. Court Administration				
d. Technology Services/IT Staff				
e. Budget Dept.				
f. Interpreters				
g. Interpreter Coordinator				
h. Other:				

Deliverable 4: Evaluation Data Collection Tools [Updated]

	YES	NO	DK/ NA	COMMENTS
GENERAL/OVERVIEW				
4. Does the system provide:				
a. two-way video?				
b. a microphone for each speaker?				
5. Can the system be used for:				
a. consecutive interpretation?				
b. simultaneous interpretation?				
c. sight translation?				
d. client/attorney confidential meeting?				
VIDEO CAPABILITIES				
6. Can the interpreter				
a. see all participants at the other location (judicial officer, attorney, LEP user, interpreter, witnesses, court clerk, bailiff)?				
b. see his/her own image on the monitor?				
c. see pre-set camera angles/views of key courtroom participants?				
7. Does the interpreter have to use pan or zoom features to see key court participants?				
8. Can all court participants see the interpreter?				
9. Can court participants see the interpreter's:				
a. face				
b. upper body				
c. hand gestures				

Deliverable 4: Evaluation Data Collection Tools [Updated]

	YES	NO	DK/ NA	COMMENTS
d. the interpreter's environment for context? (e.g. can the courtroom participants tell if the interpreter is taking notes, or adjusting switches, or pressing buttons, or using the mouse?)				
AUDIO CAPABILITIES				
10. Can the interpreter hear all participants at the other location?				
11. Can the interpreter be heard by all other participants?				
CONFIDENTIAL CONFERENCING				
12. Can the LEP court user and their attorney speak confidentially using VRI technology if needed?				
13. Can the monitor showing the interpreter be blocked visually from others to maintain confidentiality if needed?				
DOCUMENT EXCHANGE				
14. Are court participants able to exchange documents?				
15. Is a separate document camera used for sight translation of documents?				
16. Is there equipment (scanner or computer) that can be used to send information to the interpreter?				
TECH SUPPORT				
17. Is there an IT support list with contact numbers for contacting local court IT?				
a. Has this list been provided to all court staff who will be using equipment?				

Deliverable 4: Evaluation Data Collection Tools [Updated]

	YES	NO	DK/ NA	COMMENTS
18. Is there an IT support list with contact numbers for contacting key vendor personnel?				
a. Has this list been provided to all court staff who will be using equipment?				
19. Is there a plan in place for system failures?				
TRAINING & DOCUMENTS				
20. Are operating instructions posted on the VRI equipment?				Copy available?
21. Are benchcards available?				Copy available?
(If your answer to question 21 is "YES", answer questions 22 - 24)				
22. Does the benchcard include a brief description of types of court proceeding appropriate for VRI?				
23. Does the benchcard include a checklist of things to consider or undertake during a court proceeding, such as:				
a. checking with court staff to see that equipment is operational				
b. confirming visibility and audibility of court user and interpreter				
c. establishing consent for VRI on the record				
d. asking everyone to inform the judicial officer regarding any technical difficulties				
e. providing a brief introduction of the case including background information and case elements if the interpreter was not provided court				

Deliverable 4: Evaluation Data Collection Tools [Updated]

	YES	NO	DK/ NA	COMMENTS
documents prior to the court proceeding				
f. describing out loud any reason for delays so remote interpreter is aware of what is happening				
g. making sure court clerk can be heard by interpreter when administering oaths and calendaring hearings				
24. Are benchcards available online?				
25. Are judicial officers provided with a script to introduce the remote interpreter to the courtroom?				Copy available?
COURT PERSONNEL TRAINING				
26. Was training in use of VRI provided to:				
a. judicial officers				
b. court staff				
c. interpreter coordinators				
d. IT staff				
e. attorneys				
f. interpreters				
27. How many training sessions were conducted?				
28. What was the duration of each session?				
29. Did training include guidelines about the types of court proceedings appropriate for VRI?				
30. Have any supplemental written training materials been provided to:				Copy available?
a. judicial officers				
b. interpreters				

Deliverable 4: Evaluation Data Collection Tools [Updated]

	YES	NO	DK/ NA	COMMENTS
c. court staff				
d. IT staff				
e. other:				
31. During training, were attorneys informed about the private attorney-client conversation feature?				
32. Have future trainings been scheduled?				
33. Is training information included on the court website or intranet?				
34. Are there written procedures specifying each of the following?				Copy available?
a. pre-court proceeding protocols				
b. court proceeding protocols				
c. interpreter scheduling procedures				
d. technical procedures				
e. roles of court staff				
f. rights of LEP court users				
g. informed consent procedures				
h. court proceeding rules				
i. how to conduct introductions				
j. providing interpreter with background material and case documents before a VRI event				
k. confirming interpreter is ready				
l. other:				

Deliverable 4: Evaluation Data Collection Tools [Updated]

	YES	NO	DK/ NA	COMMENTS
INTERPRETER TRAINING				
35. Did interpreter training include information about:				
a. any scripts to be used during a court proceeding				
b. ethics				
c. technology and equipment use				
d. how to respond to technical problems				
e. how/when to speak up if part of an interpretation is missed or clarification is needed				
f. skills required for VRI				
g. best practices in VRI				
h. risks of VRI				
i. interpreter's obligations in VRI				
SCHEDULING				
36. Is block scheduling being used?				

37. When did you start planning for this implementation?

38. When was the first meeting regarding this project?

39. For which type of court proceeding is VRI going to be used at your court?

Arraignment

Traffic

Civil

Criminal

Pleas

Deliverable 4: Evaluation Data Collection Tools [Updated]

Trial

Other (Please List): _____

40. Please describe the VRI setup at your court:

a. Will court participants be able to take intercept surveys in court using a tablet or computer?

b. Will off-site interpreters use a tablet or a computer for taking intercept survey?

41. What changes have been made in interpreter scheduling for VRI implementation?

42. Was the California Federation of Interpreters (CFI) provided notification of the interpreter training?
Did CFI attend the interpreter training?

BEFORE BEGINNING OBSERVATIONS AT SITE	COMMENTS
<input type="checkbox"/> Scan completed site visit checklist	
<input type="checkbox"/> Email scanned checklist to site coordinator	
<input type="checkbox"/> Ask if there are differences between checklist and current setup	
<input type="checkbox"/> Note differences	
<input type="checkbox"/> Modify observation rubric as needed for that site	

NOTES/COMMENTS:

POST-PILOT ONLINE STAKEHOLDER SURVEY

VRI: ONLINE STAKEHOLDER SURVEY

Start of Block: Block 1

Q1 What is your role in court?

- Judicial Officer (1)
 - Attorney (2)
 - Interpreter (3)
 - Interpreter coordinator (4)
 - IT staff (5)
 - Courtroom staff (bailiff, clerk, etc.) (6)
 - Other court staff (7)
-

Q2 At which court do you work?

- Sacramento Superior Court (1)
 - Merced Superior Court (2)
 - Ventura Superior Court (3)
-

Q3 At which location(s) did you participate in or observe VRI pilot events? [Select all that apply]

- Sacramento: Carol Miller Justice Center (Dept. 81) (1)
 - Sacramento: Main Jail Courthouse (Dept. 63) (2)
 - Merced Courthouse (Courtroom 9) (3)
 - Los Banos Courthouse (Courtroom 13) (4)
 - Ventura Courthouse (Courtroom 10) (5)
 - Oxnard Courthouse (Courtroom J5) (6)
-

Q4 Prior to this pilot, did you ever participate in any court event that used Video Remote Interpreting (VRI)?

- Yes (1)
 - No (2)
-

Q5 During this pilot, on average per month, roughly, how many court events that used VRI did you participate in or observe?

- None (1)
 - 1–10 (2)
 - 11–20 (3)
 - 21–30 (4)
 - 31–40 (5)
 - 41–50 (6)
 - More than 50 (7)
-

Q6 Prior to participating in this pilot, was your opinion about VRI use in a courtroom setting positive, negative, or neither?

- Extremely positive (1)
 - Slightly positive (2)
 - Neither positive nor negative (3)
 - Slightly negative (4)
 - Extremely negative (5)
-

Q7 After participating in this pilot, did your opinion about the use of VRI in a courtroom setting...

- become more positive, (1)
 - become more negative, or (2)
 - it did not change? (3)
-

Display This Question:

If Q1 = Judicial Officer

Or Q1 = Attorney

Or Q1 = Interpreter

Q8 In general, during the pilot, how effective do you think VRI was for each of the following case types?

	Not at all effective (1)	Somewhat effective (2)	Effective (3)	Don't know/No basis for opinion/Not applicable (4)
Traffic (1)	<input type="radio"/>	<input type="radio"/>	<input type="radio"/>	<input type="radio"/>
Felony (2)	<input type="radio"/>	<input type="radio"/>	<input type="radio"/>	<input type="radio"/>
Infraction (3)	<input type="radio"/>	<input type="radio"/>	<input type="radio"/>	<input type="radio"/>
Misdemeanor (4)	<input type="radio"/>	<input type="radio"/>	<input type="radio"/>	<input type="radio"/>
Drug Court (5)	<input type="radio"/>	<input type="radio"/>	<input type="radio"/>	<input type="radio"/>
Probate (6)	<input type="radio"/>	<input type="radio"/>	<input type="radio"/>	<input type="radio"/>
Harassment (7)	<input type="radio"/>	<input type="radio"/>	<input type="radio"/>	<input type="radio"/>
Small Claims (8)	<input type="radio"/>	<input type="radio"/>	<input type="radio"/>	<input type="radio"/>
Unlawful Detainer (9)	<input type="radio"/>	<input type="radio"/>	<input type="radio"/>	<input type="radio"/>
Domestic Violence (10)	<input type="radio"/>	<input type="radio"/>	<input type="radio"/>	<input type="radio"/>
Other Civil Cases (11)	<input type="radio"/>	<input type="radio"/>	<input type="radio"/>	<input type="radio"/>

Display This Question:

If Q1 = Judicial Officer

Or Q1 = Attorney

Or Q1 = Interpreter

Q9 In general, during the pilot, how effective do you think VRI was for each of the following?

	Not at all effective (1)	Somewhat effective (2)	Effective (3)	Don't know/No basis for opinion/Not applicable (4)
in-custody defendants (1)	<input type="radio"/>	<input type="radio"/>	<input type="radio"/>	<input type="radio"/>
out-of-custody defendants (2)	<input type="radio"/>	<input type="radio"/>	<input type="radio"/>	<input type="radio"/>
cases with multiple defendants (3)	<input type="radio"/>	<input type="radio"/>	<input type="radio"/>	<input type="radio"/>

Q10 In general, during the pilot, do you think VRI was used for events of appropriate length?

- Yes (1)
- No (2)

Display This Question:

If Q1 = Attorney

Q11 During the VRI events you participated in, did you use VRI solutions to communicate confidentially with your client?

- Yes (1)
- No (2)
- Don't know/No basis for opinion/Not applicable (3)

Display This Question:

If Q11 = Yes

Q12 How effective do you feel VRI was for confidential communication?

- Very effective (1)
- Somewhat effective (2)
- Neither effective nor ineffective (3)
- Somewhat ineffective (4)
- Very ineffective (5)

Q13 Based on your participation in the pilot, how much do you agree or disagree with the following statement?

Overall, VRI provided effective interpreting to LEP court users.

- Strongly agree (1)
- Agree (2)
- Neither agree nor disagree (3)
- Disagree (4)
- Strongly Disagree (5)

Q14 Based on your participation in the pilot, how much do you agree or disagree with the following statement?

VRI with a registered/certified interpreter provides more effective interpreting than in-person interpreting with a non-certified/non-registered or provisionally qualified interpreter.

- Strongly agree (1)
- Agree (2)
- Neither agree nor disagree (3)
- Disagree (4)
- Strongly Disagree (5)

Q15 Based on your participation in the pilot, how much do you agree or disagree with the following statement?

VRI allowed the LEP court user to meaningfully participate in court proceedings.

- Strongly agree (1)
 - Agree (2)
 - Neither agree nor disagree (3)
 - Disagree (4)
 - Strongly Disagree (5)
-

Q16 Based on your participation in the pilot, how much do you agree or disagree with the following statement?

If LEP court users do not want to participate in VRI, they should be informed that their hearing may be continued to a later date in order to secure an in-person interpreter (which may necessitate a second court appearance).

- Strongly agree (1)
- Agree (2)
- Neither agree nor disagree (3)
- Disagree (4)
- Strongly Disagree (5)

End of Block: Block 1

Start of Block: Vendors

Q17 Did you participate in or observe court events that used a VRI solution provided by:

- Paras and Associates only (1)
- Connected Justice only (2)
- Participated in/observed events that used solutions provided by both vendors (3)
- Don't know/No basis for opinion/Not applicable (4)

Display This Question:

If Q17 = Participated in/observed events that used solutions provided by both vendors

Q18 Overall, which vendor do you feel provided better a better VRI solution, or was there no significant difference?

- Paras and Associates (1)
- Connected Justice (2)
- There was no significant difference between vendors in services provided (3)
- Don't know/No basis for opinion/Not applicable (4)

Display This Question:

If Q17 = Participated in/observed events that used solutions provided by both vendors

Q19 Overall, which vendor do you think provided better IT support?

- Paras and Associates (1)
- Connected Justice (2)
- There was no significant difference in IT support (3)
- Don't know/No basis for opinion/Not applicable (4)

End of Block: Vendors

Start of Block: Training

Q20 Did you receive training before using VRI during an actual courtroom event?

- Yes (1)
- No (2)

Display This Question:

If Q20 = Yes

Q21 Overall do you feel that the amount of training you received on VRI was sufficient?

- Yes (1)
- No (2)

Display This Question:

If Q21 = No=

Q22 Can you please elaborate on your response?

End of Block: Training

Start of Block: Phase 2 (Inter-court)

Q23 During the pilot, did you participate in or observe VRI events that used interpreters from a court located in another county?

- Yes (1)
- No (2)
- Don't recall/Don't know (3)

Display This Question:

If Q23 = Yes

Q24 In your opinion,

- was VRI more effective when the interpreter was located within the same county, (1)
- was VRI more effective when the interpreter was located at a different county, (2)
- or there was no difference in effectiveness based on the location of the interpreters? (3)
- Don't recall/Don't know (4)

Display This Question:

If Q23 = Yes

Q25 Why?

End of Block: Phase 2 (Inter-court)

Start of Block: Interpreters Only

Display This Question:

If Q1 = Interpreter

Q26 For which language did you primarily provide interpretation services during the VRI pilot?

- Spanish (1)
- Simplified Chinese or "Mandarin" (2)
- Punjabi (3)
- Russian (4)
- Vietnamese (5)
- Other (please specify) (6) _____

Display This Question:

If Q1 = Interpreter

And Q17 = Participated in/observed events that used solutions provided by both vendors

Or if

Q1 = Interpreter

And Q17 = Paras and Associates only

Q27 Please rate the following aspects of the interpreter station setup provided by Paras and Associates.

	Very good (1)	Good (2)	Adequate (3)	Less than adequate (4)	Very poor (5)
Comfort of the interpreter workstation (1)	<input type="radio"/>	<input type="radio"/>	<input type="radio"/>	<input type="radio"/>	<input type="radio"/>
Ease of use of the equipment (2)	<input type="radio"/>	<input type="radio"/>	<input type="radio"/>	<input type="radio"/>	<input type="radio"/>
Audio quality on the interpreter end (3)	<input type="radio"/>	<input type="radio"/>	<input type="radio"/>	<input type="radio"/>	<input type="radio"/>
Video quality on the interpreter end (4)	<input type="radio"/>	<input type="radio"/>	<input type="radio"/>	<input type="radio"/>	<input type="radio"/>
Ability to do sight translation (5)	<input type="radio"/>	<input type="radio"/>	<input type="radio"/>	<input type="radio"/>	<input type="radio"/>
Ability to interpret confidential conversations between the LEP court user and their attorney (6)	<input type="radio"/>	<input type="radio"/>	<input type="radio"/>	<input type="radio"/>	<input type="radio"/>

Display This Question:

If Q1 = Interpreter

And Q17 = Participated in/observed events that used solutions provided by both vendors

Or If

Q1 = Interpreter

And Q17 = Connected Justice only

Q28 Please rate the following aspects of the interpreter station setup provided by Connected Justice.

	Very good (1)	Good (2)	Adequate (3)	Less than adequate (4)	Very poor (5)
Comfort of the interpreter workstation (1)	<input type="radio"/>	<input type="radio"/>	<input type="radio"/>	<input type="radio"/>	<input type="radio"/>
Ease of use of the equipment (2)	<input type="radio"/>	<input type="radio"/>	<input type="radio"/>	<input type="radio"/>	<input type="radio"/>
Audio quality on the interpreter end (3)	<input type="radio"/>	<input type="radio"/>	<input type="radio"/>	<input type="radio"/>	<input type="radio"/>
Video quality on the interpreter end (4)	<input type="radio"/>	<input type="radio"/>	<input type="radio"/>	<input type="radio"/>	<input type="radio"/>
Ability to do sight translation (5)	<input type="radio"/>	<input type="radio"/>	<input type="radio"/>	<input type="radio"/>	<input type="radio"/>
Ability to interpret confidential conversations between the LEP court user and their attorney (6)	<input type="radio"/>	<input type="radio"/>	<input type="radio"/>	<input type="radio"/>	<input type="radio"/>

End of Block: Interpreters Only

Start of Block: Interpreter Coordinators Only

Display This Question:

If Q1 = Interpreter coordinator

Q29 In your opinion, did having the option to use VRI decrease the number of reschedulings or delays caused by interpreter unavailability?

- Yes (1)
- No (2)
- Not sure (3)

Display This Question:

If Q1 = Interpreter coordinator

Q30 In your opinion, did having the option to use VRI increase the use of registered/certified interpreters?

- Yes (1)
- No (2)
- Not sure (3)

Display This Question:

If Q1 = Interpreter coordinator

Q31 In your opinion, did using VRI decrease interpreting costs at your court?

- Yes (1)
- No (2)
- Not sure (3)

End of Block: Interpreter Coordinators Only

Start of Block: Open Ends

Q32 In your opinion, what, if any, were the major challenges of VRI during the pilot?

Q33 In your opinion, what, if any, are the major benefits of VRI?

Q34 What recommendations would you make to other courts that are considering implementing VRI?

Q35 Please provide any other comments about the pilot.

Q36 Thank you for contributing your perspective to this important process.

Please click "Next" to submit your responses.

End of Block: Open Ends

Appendix E. Evaluation Sub-questions

SUB-QUESTIONS	DATA SOURCES			
	Event Surveys	On-site observations	Post-pilot online Survey	Scheduling data
A. Were each of the court participants able to hear all other court participants during an interpreted event?	✓			
B. Were each of the court participants able to see all other court participants during an interpreted event?	✓			
C. Did stakeholders believe that VRI provided effective interpreting?	✓		✓	
D. Was the LEP able to speak confidentially with his/her attorney during the event (if there was a need to do so)?	✓	✓	✓	
E. Were the audio and video feeds synchronized?	✓	✓		
F. Was there a technical problem with the VRI equipment that delayed the start of the court proceeding more than 10 minutes?	✓	✓		
G. Was there a technical problem with the VRI equipment during the court proceeding that delayed it more than 2 minutes?	✓	✓		
H. Was there a technical problem with the VRI equipment that required the court proceeding to be rescheduled?	✓	✓		
I. Was there a significant difference across vendors with respect to audio and video synchronization?	✓	✓		
J. For technical problems with the VRI equipment that delayed the start of the court proceeding by more than 10	✓	✓		

SUB-QUESTIONS	DATA SOURCES			
	Event Surveys	On-site observations	Post-pilot online Survey	Scheduling data
minutes, was there a significant difference across vendors?				
K. For technical problems with the VRI equipment during the court proceeding that delayed the proceeding by more than 2 minutes, was there a significant difference across vendors?	✓	✓		
L. For technical problems with the VRI equipment that required the court proceeding to be rescheduled, was there a significant difference across vendors?	✓	✓		
M. Did the perceived effectiveness of VRI vary significantly across case type?	✓		✓	
N. Did the perceived effectiveness of VRI vary significantly across events interpreted in different languages?	✓		✓	
O. Did the perceived effectiveness of VRI vary based on the length of the event?	✓			
P. Did the perceived effectiveness of VRI vary significantly across the two vendors?	✓		✓	
Q. Did the perceived effectiveness of VRI vary significantly between the two modalities?	✓			
R. Did the perceived effectiveness of VRI vary based on whether or not the event included consecutive interpreting?	✓			
S. Did the perceived effectiveness of VRI vary based on whether or not the event included simultaneous interpreting?	✓			
T. Did the perceived effectiveness of VRI vary based on whether or not the LEP needed to speak confidentially with his/her	✓		✓	

SUB-QUESTIONS	DATA SOURCES			
	Event Surveys	On-site observations	Post-pilot online Survey	Scheduling data
attorney during the event (if there was a need to do so)?				
U. Did the perceived effectiveness of VRI vary based on whether or not the event included sight translation?	✓			
V. Did LEP satisfaction with interpretation vary significantly across the two vendors?	✓			
W. Did LEP satisfaction with interpretation vary significantly across the two modalities?	✓			
X. Did LEP satisfaction with interpretation vary significantly with ease of use of equipment?	✓			
Y. Did LEP satisfaction with interpretation vary significantly across events interpreted in different languages?	✓			
Z. Did an analysis of observations of VRI and in-person interpreted court events detect any significant difference in event length between the two modalities for traffic court events?		✓		
AA. Did an analysis of observations of VRI and in-person interpreted court events detect any significant difference between the two modalities in the number of times the interpreter requested that information be repeated/clarified?		✓		
BB. Did an analysis of observations of VRI and in-person interpreted court events detect any significant difference between the two modalities in the number of times the interpreter requested that any event participant slow down?		✓		

SUB-QUESTIONS	DATA SOURCES			
	Event Surveys	On-site observations	Post-pilot online Survey	Scheduling data
CC. Did an analysis of observations of VRI and in-person interpreted court events detect any significant difference in multiple participants speaking at the same time between the two modalities?		✓		
DD. Did an analysis of observations of VRI court events detect any significant difference between the two vendors in the following: 1. Blurry or pixelated image 2. Insufficient lighting 3. Out of range of camera		✓ ✓ ✓		
EE. Did stakeholders feel that VRI was equally appropriate for events where the defendant was in custody and where the defendant was not in custody?			✓	
FF. Did stakeholders feel that VRI was effective for events with multiple defendants?			✓	
GG. Did stakeholders feel that VRI was equally effective for events interpreted by an interpreter in the same county versus those where the interpreter was located in another county?			✓	
HH. Did participants in the pilot feel they received sufficient training in VRI use prior to or during the pilot?			✓	
II. Do key stakeholders' opinions report that their opinions regarding VRI have changed as a result of participating in the VRI pilot?			✓	
JJ. Did interpreter coordinators feel that access to VRI increased the use of registered/certified interpreters?			✓	

SUB-QUESTIONS	DATA SOURCES			
	Event Surveys	On-site observations	Post-pilot online Survey	Scheduling data
KK. Did interpreter coordinators feel that access to VRI decrease the number of delays and/or reschedulings of events caused by lack of an available interpreter?			✓	
LL. Did interpreter coordinators feel that access to VRI reduced overall interpreting costs?			✓	
MM. Did a review of interpreter scheduling data for a period of 3 months prior to the pilot and the three months during the pilot, detect any significant difference in the use of non-certified/registered interpreters?				✓
NN. Did a review of interpreter scheduling data for a period of 3 months prior to the pilot and the three months during the pilot, detect any significant difference in the number of delays or reschedulings of LEP court users' events due to the lack of access to a certified/registered in-person interpreter?				✓
OO. Were VRI best practices followed? <i>INTERPRETER</i>				
1. Interpreter communicated with LEP court user before court proceeding?	✓			
2. Interpreter could intervene during event?	✓			
3. Interpreter had sufficient time to interpret?	✓			
4. Interpreter was provided info about case before court proceeding?	✓			

SUB-QUESTIONS	DATA SOURCES			
	Event Surveys	On-site observations	Post-pilot online Survey	Scheduling data
<i>JUDICIAL OFFICER</i>				
5. Judicial officer introduced all participants?	✓			
6. Judicial officer told participants to speak clearly, slowly, one at a time?	✓	✓		
7. LEP court user was asked to consent on record to using VRI?	✓	✓		
8. Event needed to be stopped because of an objection to the use of VRI?	✓			
9. Did judicial officer feel that the VRI event allowed for effective communication between the LEP court user and the courtroom?	✓			
10. Judicial officer asked interpreter to state name, credentials on record?		✓		
11. Judicial officer told interpreter how to ask for clarification/missed info?		✓		

Appendix F: Bibliography

- Assembly Bill No. 1657. (2014). *Courts: interpreters*. California Assembly 2013-2014 Regular Session, Ch. 721.
- Braun, S. (2011). Recommendations for the use of video-mediated interpreting in criminal proceedings. In S. Braun, & J. L. Taylor (Eds.), *Videoconferencing and remote interpreting in criminal proceedings* (pp. 265-287). Guildford: University of Surrey.
- Braun, S. (2013). Keep your distance? Remote interpreting in legal proceedings: A critical assessment of a growing practice. *Interpreting*, 15(2), 200-228.
- Braun, S., & Taylor, J. L. (2011a). Video-mediated interpreting in criminal proceedings: Two European surveys. In S. Braun, & J. L. Taylor (Eds.), *Videoconference and remote interpreting in criminal proceedings* (pp. 59-84). Guildford: University of Surrey.
- Braun, S., & Taylor, J. L. (2011b). Video-mediated interpreting: An overview of current practice and research. In S. Braun, & J. L. Taylor (Eds.), *Videoconference and remote interpreting in criminal proceedings* (pp. 27-57). Guildford: University of Surrey.
- California Federation of Interpreters Local 39000. (2016, June 22). Letter to Chief Justice Tani Cantil-Sakauye, Judicial Council of California. Oakland, California.
- California Federation of Interpreters. (2013, September). Video Remote Interpreting Position Statement. California.
- California Federation of Interpreters. (2016). *Video Remote Interpreting (VRI) for the Deaf and Hard of Hearing in California Courts: A Fabricated Success Story*.
- Carlson, V. L. (2011). *An Examination of Remote Language Interpreting in the Minnesota Trial Courts*. Chaska, Minnesota: Carver County Court Administration, First Judicial District.
- Committee to Improve Interpreting and Translation in the Wisconsin Courts Report to the Director of State Courts. (2000). *Improving Interpretation in Wisconsin's Courts*.
- Institute for Social Research. (2010). *2010 Language Need and Interpreter Use in California Superior Courts*.
- Judicial Council of California. (2007, January 1). California Rules of Court.
- Judicial Council of California. (2012). *Recommended Guidelines for Video Remote Interpreting (VRI) for ASL-Interpreted Events*. San Francisco, CA: Judicial Council of California.
- Judicial Council of California. (2015). *Strategic Plan for Language Access in the California Courts*. San Francisco.

- Judicial Council of California. (2017, April 24). *FAQs - court interpreters*. Retrieved from California Courts: The Judicial Branch of California: <http://www.courts.ca.gov/2683.htm>
- Kalina, S. (2012). Quality in interpreting. In Y. Gambier, & L. van Doorslaer, *Handbook of Translation Studies* (Vol. 3, pp. 134-140). Amsterdam, NL: John Benjamins Publishing Company.
- Kurz, I. (2001). Conference interpreting: Quality in the ears of the user. *Meta*, 46(2), 394-409.
- Minnesota Judicial Branch. (2010). Use of Remote Spoken Language Interpreter Services.
- Minnesota Judicial Branch. (2013, May). Bench Card: Video Remote Interpreting in the Courtroom. Minnesota, USA.
- Moser-Mercer, B. (2003, May 19). *Remote interpreting: Assessment of human factors and performance parameters*. Retrieved from aiic.net: <http://aiic.net/p/1125>
- Moser-Mercer, B. (2005). Remote interpreting: Issues of multi-sensory integration in a multilingual task. *Meta*, 50(2), 727-738.
- Napier, J. (2011). Here or there? An assessment of video remote signed language interpreter-mediated interaction in court. In S. Braun, & J. L. Taylor (Eds.), *Videoconference and remote interpreting in criminal proceedings* (pp. 145-185). Guildford: University of Surrey.
- Napier, J. (2012). Exploring Themes in Stakeholder Perspectives of Video Remote Interpreting in Court. In C. J. Kellett Bidoli (Ed.), *Interpreting across Genres: Multiple Research Perspectives* (pp. 219-254). Trieste, Italy: EUT Edizioni Università di Trieste.
- National Center for State Courts. (2014). *Remote Interpreting Guide for Courts and Court Staff*.
- National Center for State Courts. (2015). *2015 Language Need and Interpreter Use Study*.
- National Consortium of Interpreter Education Centers. Interpreting Via Work Team. (2010). *Steps toward identifying effective practices in video remote interpreting*. National Consortium of Interpreter Education Centers.
- New York State Unified Court System. Division of Professional and Court Services. Office of Language Access. (2015). *Working with interpreters by video or teleconference: Tips for Remote Interpreting*. New York, New York: NYS Unified Court System. Retrieved from <https://www.nycourts.gov/courtinterpreter/pdfs/CISTipSheet.pdf>

- New York State Unified Court System. Office of Court Administration. Division of Court and Professional Services. Office of Court Interpreting Services. (2011). *Remote Interpreting Operational Standards*. New York, New York: New York State Unified Court System.
- Ninth Judicial Circuit Court of Florida. (2016, August 2). *Video Remote Interpreting: The Ninth Circuit and the Florida Experience*.
- Oregon Judicial Department. Court Language Access Services. (2016). *A strategic plan for implementing enhanced language access in the Oregon state courts*. Salem, Oregon: Oregon Judicial Department.
- Public Law Research Institute. (2013). *Enhancing language access services for LEP court users: A review of effective language access practices in California's superior courts*.
- Ratified VRI Agreement between Region 3 and CFI. (2014, August 15). Retrieved from <https://cfi.memberclicks.net/assets/docs/r3vrisideletter.pdf>
- Rule 2.890. Professional conduct for interpreters. (2017, February 1). *2017 California Rules of Court*.
- Schaben, K. M. (2014). *Improving language access: A pilot video remote interpreter system*. Yuma, Arizona.
- Schauffler, R. (2008). *The Provision of Court Interpreter Services in Civil Cases in California: An Exploratory Study*. Williamsburg, VA: National Center for State Courts.
- Shelsinger, M. (1997). Quality in Simultaneous Interpreting. In Y. Gambier, D. Gile, & C. Taylor (Eds.), *Conference Interpreting: Currents trends in research: Proceedings of the International Conference on Interpreting--What do we know and how?* (pp. 123-132). Amsterdam, NL: John Benjamins Publishing Company.
- Superior Court of California County of Fresno. (2016). *Minimum Technology Guidelines for VRI in Spoken Language*.
- Supreme Court of Florida. Commission on Trial Court Performance and Accountability. (2010). *Recommendations for the Provision of Court Interpreting Services in Florida's Trial Courts*. Tallahassee, Florida.
- Tyler, T. (1997). Citizen Discontent with Legal Procedures: A Social Science Perspective on Civil Procedure Reform. *American Journal of Comparative Law*, 871-904.
- U.S. Department of Justice. Civil Rights Division. Disability Rights Section. (2014). *Effective Communication*. Washington, DC: U.S. Department of Justice. Retrieved from <https://www.ada.gov/effective-comm.htm>.

Vagenas, K. J., Clarke, T., & O'Connell, K. (2014). *Wisconsin remote interpreting: Needs assessment for developing a pilot*. Williamsburg, VA: National Center for State Courts.

Video Interpreting Task Force. (2010). *Video Remote Interpreting*. Registry of Interpreters for the Deaf.

December 28, 2018

Dear VRI Pilot Workstream,

We would like to thank the VRI Workstream for allowing the California Federation of Interpreters (CFI) and the Interpreters Guild of America (IGA) to make comments regarding the proposed *Recommended Guidelines for Video Remote Interpreting (VRI) for Spoken Language-Interpreted Events* and findings of the VRI pilot project.

CFI and IGA represents approximately 1,000 staff and independent court interpreters in the state court system providing access to justice for LEP court users. The work our members perform daily across the state allows all participants— including English speaking judges, lawyers, social workers, probation officers, security personnel and many others— to communicate efficiently thereby ensuring that justice is served.

As a labor union, we will continue in our fiduciary duty to protect our members' interest, as well as promote incorporating court interpreting's best professional practices and ethics into any programs dedicated towards providing language access in the courts. Although our union's primary commitment is to demand fair compensation and equitable treatment for court interpreters, we also play an instrumental role in ensuring due process for LEP court users. Both CFI and IGA, representing the full spectrum of employee interpreters and independent contractors respectively, firmly submit that in-person interpreting is essential in providing meaningful language access and protecting due process for LEP court users. We fully support the premise that in-person services are always preferred for court proceedings as stated in recommendation 12 of the *Strategic Plan for Language Access in the California Courts*.

We are not against the limited use of VRI to expand language access to areas where otherwise qualified in-person interpreters are not immediately available. We are of the opinion that VRI must only be used as a last resort for the limited purpose of brief routine court events that are not complex and non-evidentiary in nature. In fact, both CFI and IGA support using VRI to expand access outside of courtroom proceedings where there is a great unmet need and VRI can be effective for one-on-one, low stakes communications which are so very necessary for the processing and preparation of cases before moving to filing charges and proceeding to the hearing stages. Examples of using VRI for non-court events can be such as, but not limited to, the following language access events: probation interviews, prehearing witness and criminal defendant interviews, as well as court ordered programs.

We are against misapplication of VRI such that it diminishes meaningful access for LEP court users or violates due process. We are against the misapplication of VRI for the purpose of cutting cost at the expense of effective, accurate, and efficient communication. We are against the misapplication of VRI for the purposes of courts not sharing interpreter resources (intra use of VRI).

It is CFI and IGA contend that the VRI pilot *did not* capture the data necessary to clearly deem the pilot a success. The purpose of interpreting is to provide LEP court users' full and meaningful access to justice and to ensure the protection of due process rights. The limited information gathered by the pilot did not provide adequate support for the positive outcomes reported. The study did not include the gathering of fundamental and essential information regarding due process, whether the use of VRI increased use and access to certified and registered interpreters as opposed to provisionally qualified interpreters; additionally, the data compilation did not capture information on the interconnectivity, effectiveness and reliability of technology and equipment. In truth, the pilot did not last 6 months; the project expanded to a time period of over a year due to technical difficulties. Moreover, the conclusion of the pilot did not allude to any mechanisms for control and oversight for future VRI use to safeguard LEP court users' full and meaningful access to justice.

Most notably, interpreters who participated in the VRI pilot were not interviewed by San Diego State University (SDSU) Research Foundation nor were they asked to participate in the weekly telephonic meetings conducted by Judicial Council staff and select members of the VRI Workstream. This deprived the VRI study from crucial frontline intelligence, excluded the primary conduits of language access in the justice system from the ongoing process, and failed to be transparent and inclusive. Interpreters are the catalyst of communication and are at risk of losing their certification through a technological process that under the best circumstances is prone to error rates beyond the norm for in-person interpreting. For VRI to work correctly, accurately, and serve its purpose, the certified/registered court interpreters and the LEP individuals should be the principal consultants of each and every step of this process.

Competent interpretation requires the highest level of proficiency in at least two languages, extensive focus and concentration, intuition of body language cues, alertness to speech patterns and tone, and the ability to simultaneously process all the information in a fraction of a second. The use of VRI in courts adds another layer of difficulty to interpreters by asking interpreters to operate several layers of equipment that otherwise would not exist with in-person interpreting. Our members who participated in the pilot expressed frustration, concerns as to whether there were inaccuracies and omissions, and work dissatisfaction in comparison to in-person interpreting. These interpreter pilot participants have expressed that VRI takes longer than in-person, is inefficient, highly prone to error, disposed to confusion, and as a norm, has many technical problems and delays. Additionally, interpreter VRI work stations lack proper ergonomics, which adds yet another level to the difficulty of interpreting and interpreters discomfort.

Nevertheless, with the spirit of Language Access in mind, CFI and IGA make the following recommendations to the proposed *Recommended Guidelines for Video Remote Interpreting (VRI) for Spoken Language-Interpreted Events*:

Prerequisites

- VRI is the unit work of CFI represented employee interpreters of the California Courts throughout the state; the only time an interpreter other than a represented employee is authorized to perform VRI is if there is no available represented employee interpreter available for the language pair.
- Any and all VRI events be in compliance with the MOU, its VRI article, and/or VRI side letters for each of the four Regions.

- VRI *is not* appropriate for every and all in-court proceedings/hearings; the level of accuracy and precision is demonstrably proven to decline with any increase in the number of participants, the complexity of the hearing, and the use of simultaneous over consecutive mode. Insofar as in-court proceedings, CFI and IGA recommends: in-court proceedings be limited in time and scope (15-20 minutes); VRI be used as a “last resort” after exhausting all other possibilities, including utilizing the cross-assignment system statewide; VRI be employed in emergency situations that are time sensitive, carry dire legal consequences, or require public safety, such as, but not limited to bail/own recognizance hearings, arraignments, and domestic violence/civil harassment temporary restraining orders. VRI must not be used as a convenience, nor as a cost-cutting device at the expense of meaningful language access and protection of due process rights.
- CFI and IGA recommends that any VRI usage be used for **inter** court purposes.
- Interpreter provider courts should be mindful of interpreter fatigue when assigning interpreters to perform VRI. Interpreters should not be assigned to more than half day assignments, rotations should be implemented, and a minimum of 5-minute breaks should be given in between cases. Depending on the length of the previously interpreted event, that number could go to 10 minutes, or more.
- CFI and IGA recommends that the minimum technological requirement findings from the spoken language pilot study for each of the components needed to conduct VRI-interpreted court event be mandatory for all courts who desire to become VRI courts.
- CFI and IGA recommends courts be limited to the use of the recommended vendor equipment. Maintaining equipment interconnectivity promotes uniformity of guidelines, protocol, best practices and, facilitates the sharing of interpreter resources throughout the state.
- CFI and IGA recommends that all technological requirements and equipment be thoroughly tested prior to any VRI event to provide high quality communication.
- Interpreters performing VRI services should have a permanent salary premium – to be negotiated with the Union – as compensation for the increased skill set and training, as well as the higher level of difficulty involved in the process of VRI.

Training

CFI and IGA recommends that adequate training be given to all stakeholders involve in VRI events and that interpreters who participated in the pilot be called upon to assist in the training. Training curriculum should include:

- Correct use of equipment,
- Interpreting protocols, including, but not limited to, interpreting protocols for interrupting the proceedings for repetition, or to ask for clarification.
- Legal basis to suspend and/or reschedule VRI events.
- VRI as practiced in a court setting (AVIDICUS findings) and the inherent challenges in providing VRI.
- The Court’s fundamental role to provide meaningful language access to LEP court users.
- An overview of due process as it relates to language access.
- A focused approach toward visual and auditory impediments that might arise.

- Importance of and protocols for maintaining confidentiality in a technology complex environment.
- Modes of interpreting: what they are and which is the preferred mode for VRI delivery. *Due to many technological difficulties interpreters experienced during the pilot (such as a constant echo), consecutive should be the standard mode employed.*
- Sight translations – the importance of providing documents and information a forehand for interpreters to render meaningful language access.
- Professional Standards and Ethics for Court Interpreters with a focus on how are applied in the VRI environment.
- Training should also be given to backup non-interpreter staff in case of unplanned absences.

Visual/auditory issues

Interpreters are the conduits of communication. No other individual in the court will have the knowledge and understanding of what tools are needed to make VRI events successful other than the interpreter. Every courtroom, interpreter, stakeholder, and courtroom technological capabilities differs from location to location. On a daily basis – interpreters deal with stakeholders who are soft-spoken, mumble, or speak too fast. This oftentimes results in interpreters relying on body language and even lip reading to confirm auditory uncertainties. The use of VRI adds another layer of difficulty to the interpreter’s auditory capabilities. Therefore, maintaining the option to view all stakeholders (if need be) is an essential tool for VRI to work correctly. In light of these facts, CFI and IGA recommends that:

- VRI equipment to be used in the courtrooms should be equipped with cameras that can capture all stakeholders. Having this added feature available to interpreters will facilitate their work, improve precision, and will make VRI events successful.
- Speakers, headsets, and speakerphones should project sounds clearly and have volume controls. Only consecutive modes should be utilized for speakerphones.
- Understanding that all courtrooms and courtroom technological capabilities differs at each location, courts should purchase appropriate high-quality microphones. All stakeholders and LEP court users should be near a microphone at all times during any VRI event.

Confidentiality

CFI and IGA recommends that all VRI have the capability of confidential attorney-client conferencing.

Mode of interpreting

Interpreting in the courtroom regularly involves both simultaneous and consecutive modes of interpreting; however, the decision regarding which modes of interpreting to be use must be determined by the interpreter. Interpreters are very committed to high quality, efficient, and effective communication. On a case by case basis, in-person interpreters gauge how best to be the most effective communication conduits. Thus, interpreters – depending on case by case situations – change from simultaneous to consecutive or a hybrid of both at a moment’s notice. Thinking that technology will allow for this natural flow of interchangeable modes of effective communication is unrealistic. In order to protect LEP court users’ due process rights, allow full and meaningful access to justice, and maintain precision and accuracy for meaningful language access, CFI and IGA recommends that all VRI events be conducted in consecutive mode.

Courts implementation of VRI

An important take away from the VRI study is that carefully vetted technological systems such as VRI— with specialized equipment, on site tech solutions, wide bandwidth, adequate quality of service and class of service— are prone to failure. To make VRI functional, courts should be obligated to follow all technological guidelines recommended by the California Judicial Branch.

CFI and IGA stands ready to participate in a responsible plan that integrates our main positions on VRI implementation in a manner that protects access to justice for all without any detriment to the high standards of our profession —court interpreting.

Sincerely,



Tyler T. Nguyen
CFI Region 3 Representative and
Judicial Council VRI Workstream Member



Angie Birchfield
IGA Chair and
Judicial Council VRI Workstream Member